

# GRADY-WHITE BOATS

---

P.O. Box 1527, Greenville, NC 27835-1527  
Greenville Blvd. NE, Greenville, NC 27834  
919/752-2111 FAX: 919/752-4217

## WELCOME ABOARD!

Congratulations! Welcome to the Grady-White "family" of proud and friendly boat owners.

The Grady-White you have purchased is the strongest, safest, and highest quality boat you can buy. It was built by dedicated craftsmen in the most modern boat-building facility in the United States. All of us at Grady-White Boats wish you many happy, carefree hours of boating in your Grady-White.

Your Grady-White boat meets or exceeds every safety standard of the U.S. Coast Guard and the National Marine Manufacturers Association's NMMA Certification Program. Your Grady-White's safety and seaworthiness, however, depends on your operation, maintenance and care of your boat. That's why we have put a great deal of time and thought into this owner's manual. It includes the precautions, facts and tips that will help make your boating safe and enjoyable. Please study this manual thoroughly!

My thanks to you for choosing Grady-White. All of us here at the factory are dedicated toward meriting your confidence in Grady-White Boats. Happy boating and welcome aboard.

Sincerely yours,

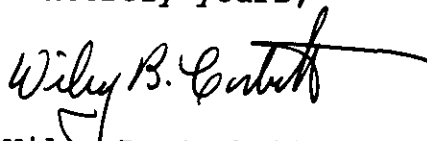

Wiley B. Corbett  
President

# TABLE OF CONTENTS

WELCOME ABOARD

## **BOATING SAFETY**

REQUIRED SAFETY EQUIPMENT.....	PAGE 7
ADDITIONAL RECOMMENDED EQUIPMENT.....	PAGE 8
BOATING SAFETY TIPS.....	PAGE 8
LOADING CAPACITY.....	PAGE 10
CERTIFICATION.....	PAGE 11-1

## **GAUGES AND SWITCHES**

INSTRUMENT PANEL.....	PAGE 12
SWITCH PANEL.....	PAGE 13
AUXILIARY FUSE PANEL.....	PAGE 16

## **STEERING**

MECHANICAL STEERING.....	PAGE 17
HYDRAULIC STEERING.....	PAGE 17
TILT STEERING.....	PAGE 18

## **BOAT OPERATION**

FUELING.....	PAGE 19
FUEL SYSTEM MAINTENANCE.....	PAGE 20
TRAILERING.....	PAGE 21
LAUNCH AND RECOVERY.....	PAGE 22
ANCHORING.....	PAGE 23
DOCKING.....	PAGE 24
THROTTLE/SHIFT CONTROL.....	PAGE 24

## **PERFORMANCE**

TRIM.....	PAGE 26
TRIM TABS.....	PAGE 27
TRIM TAB PUMP LOCATIONS.....	PAGE 28
PROPELLER.....	PAGE 29
LOAD DISTRIBUTION.....	PAGE 29

## **MAINTENANCE AND SERVICE**

FIBERGLASS FINISH.....	PAGE 30
GELCOAT.....	PAGE 31
INTERIOR.....	PAGE 32
CANVAS.....	PAGE 32
DURATRIM.....	PAGE 33
HARDWARE.....	PAGE 33
ENGINE.....	PAGE 34
GRADY DRIVES.....	PAGE 34
SCUPPERS.....	PAGE 34
HARDWARE MOUNTING.....	PAGE 34
BATTERY.....	PAGE 35
230 GULFSTREAM RIGGING COMPARTMENT.....	PAGE 36
WINTERIZATION AND STORAGE.....	PAGE 37

## HEAD OPERATING INSTRUCTIONS

PORTABLE HEAD WITH IN-LINE MACERATOR.....	PAGE 39
PORTABLE HEAD WITH DECK PUMP-OUT.....	PAGE 40

## MISCELLANEOUS

ACCESSORY WIRING COLOR CODE AND FUSE SIZES.....	PAGE 41
TYPICAL OUTBOARD INSTRUMENT AND SWITCH PANEL WIRING.....	PAGE 42
TYPICAL STERN DRIVE INSTRUMENT AND SWITCH PANEL WIRING....	PAGE 43
175 SPIRIT ACCESSORY WIRING DIAGRAM.....	PAGE 44
192 TOURNAMENT ACCESSORY WIRING DIAGRAM.....	PAGE 45
192 TOURNAMENT FRESH WATER SYSTEM.....	PAGE 46
208 ADVENTURE ACCESSORY WIRING DIAGRAM.....	PAGE 47
208 ADVENTURE FRESH WATER SYSTEM.....	PAGE 48
209 ESCAPE ACCESSORY WIRING DIAGRAM.....	PAGE 49
209 ESCAPE FRESH WATER SYSTEM.....	PAGE 50
22' TOURNAMENT ACCESSORY WIRING DIAGRAM.....	PAGE 51
22' TOURNAMENT FRESH WATER SYSTEM.....	PAGE 52
22' SEAFARER ACCESSORY WIRING DIAGRAM.....	PAGE 53
22' SEAFARER FRESH WATER SYSTEM.....	PAGE 54
23' GULFSTREAM ACCESSORY WIRING DIAGRAM.....	PAGE 55
23' GULFSTREAM FRESH WATER SYSTEM.....	PAGE 56
243 CHASE ACCESSORY WIRING DIAGRAM.....	PAGE 56-1
243 CHASE FRESH WATER SYSTEM.....	PAGE 56-2
24' EXPLORER ACCESSORY WIRING DIAGRAM.....	PAGE 57
244 EXPLORER FRESH WATER SYSTEM.....	PAGE 58
245 EXPLORER FRESH WATER SYSTEM.....	PAGE 59
246G EXPLORER FRESH WATER SYSTEM.....	PAGE 60
246GT EXPLORER FRESH WATER SYSTEM.....	PAGE 61
25' DOLPHIN ACCESSORY WIRING DIAGRAM.....	PAGE 62
250/253GT DOLPHIN FRESH WATER SYSTEM.....	PAGE 63
251 DOLPHIN FRESH WATER SYSTEM.....	PAGE 64
25' DOLPHIN DOCKSIDE POWER WIRING DIAGRAM.....	PAGE 65
HARDTOP WIRING DIAGRAM: 20'/22'/23'/24' SERIES.....	PAGE 66
HARDTOP WIRING DIAGRAM: 25' DOLPHIN SERIES/252 SAILFISH..	PAGE 67
AC WIRING SCHEMATIC AND WARNING LABEL.....	PAGE 68
WASHDOWN/LIVWELL SYSTEM.....	PAGE 69
TYPICAL FUEL TANK DRAINAGE.....	PAGE 70
HULL/LINER/DECK LAYOUT.....	PAGE 71
COMMONLY USED NAUTICAL TERMS.....	PAGE 72

INDEX  
WARRANTY

**SPECIFICATIONS**

DEALER: \_\_\_\_\_

OWNERS NAME: \_\_\_\_\_

OWNERS ADDRESS: \_\_\_\_\_

MODEL: \_\_\_\_\_

BOAT SERIAL #: \_\_\_\_\_

STEERING: \_\_\_\_\_

ENGINE OPTION: \_\_\_\_\_

STEERING CABLE LENGTH: \_\_\_\_\_

ENGINE SERIAL #: \_\_\_\_\_

CONTROL CABLE LENGTHS: \_\_\_\_\_

DRIVE SERIAL #: \_\_\_\_\_

\*\* APPROX. DRY WEIGHT  
W/O ACCESSORIES): \_\_\_\_\_

TRANSOM PLATE SERIAL #: \_\_\_\_\_

FACTORY INSTALLED PROP (ALUM): \_\_\_\_\_

\*\* OUTBOARD WEIGHTS DO NOT INCLUDE ENGINE

MODEL	CENTER- LINE LENGTH	BEAM AMID- SHIP	TRANSOM HEIGHTS (S-SGL) (T-TWIN)	TRANSOM WIDTH	HULL DRAFT	O/B MAX H.P.	MAIN FUEL CAP. (GAL)	AUX FUEL CAP. (GAL)	FRESH WATER CAP. (GAL)	APPROX HEIGHT KEEL TO TOP OF W/S
175	17'5"	89"	20"S	88"	12"	140	48			69"
190	18'11"	96"	20"S	92"	14"	200	60			72.0"
209	20'4"	96"	25"S	94"	14"	230	82		10	85.88"
208	20'4"	96"	25"S	94"	14"	230	82		10	84.5"
225G	22'2"	96"	25"S	94"	15"	230	91		10	78"
226	22'2"	96"	25"S	94"	15"	280	91	56	10	89.13"
227	22'2"	96"		94"	15"		91		10	89.13"
228G	22'2"	96"	25"S	94"	15"	280	91	56	10	89.13"
230	23'5"	111"	25S/25T	106"	17"	350	91	56	10	96.25"
231	23'5"	111"		106"	17"		90	56	10	96.25"
232G	23'5"	111"	25S/25T	106"	17"	350	91	56	10	96.25"
244	24'1"	96"	25"S	94"	15"	300	91	56	10	91"
245	24'1"	96"		94"	15"		91		10	91"
246G	24'1"	96"	25"S	94"	15"	300	91	56	10	91"
246GT	24'1"	96"	25"T	94"	15"	300	107	56	10	91"
250	25'4"	108"	25"T	108"	18"	400	150	90	10	102"
251	25'4"	108"		108"	18"	400	150	90	10	102"
252G	25'4"	114"	25"T	108"	18"	400	150	52	32	107.5"
253GT	25'4"	114"	25"T	108"	18"	400	150	90	10	102"
254	25'4"	114"		108"	18"		150		32	107.5"
255	25'4"	114"	25"T	108"	18"	400	150	52	32	107.5"
280	28'0"	127"	25"T	114"	19"	500	156	150	41	117"

\* WITH HARDTOP ADD 21"

## BOATING SAFETY

### REQUIRED SAFETY EQUIPMENT

The U.S. Coast Guard requires that every boat has specific equipment on board. The requirements vary with boat size. There are also local agencies which require additional equipment, so find out if your local regulations require more equipment than the list of Coast Guard requirements below.

Since your Grady-White is between 16 and 26 feet, it is classified as a Class 1 boat and requires the following safety equipment:

#### **FIRE EXTINGUISHER**

Every boat should be equipped with a fire extinguisher that is approved for marine use. It should be classified to extinguish Type B (gasoline, oil or grease) fires. Your fire extinguisher should be easily accessible, and each passenger should be aware of its location.

#### **PERSONAL FLOTATION**

Each passenger (and skier) must have a U.S. Coast Guard approved personal flotation device. They should be stored where they can be reached easily and quickly. These flotation devices must be in good condition and the appropriate size for the intended wearer. Small children and non-swimmers should wear these flotation devices at all times. Each Class 1 boat is also required to carry an approved Type 4 throwable flotation device, such as a ring buoy or boat cushion.

#### **HORN**

All Class 1 boats are required to carry a hand, lung, or power-operated horn that is audible for at least one mile.

#### **VISUAL DISTRESS SIGNALS**

Coast Guard-approved visual distress signals are now required when operating in U. S. waters and on the high seas. Some examples of visual distress signals include: flares, orange smoke, orange flag (day use only), and electric distress light (night use only).

#### **REGISTRATION NUMBERS**

Federal and state laws require that a power boat be registered in the state where it is principally used. Both registration numbers and validation stickers must be displayed according to the regulations, and the registration certificate must be carried on board. The boat's serial number, required on the registration form, is found on the upper right hand corner of the transom.

**LIGHTING**

All Grady-White boats are equipped with navigational lights that meet the latest requirements for inland and international waters. If there is any doubt, or if requirements change, consult your dealer.

For more information on Coast Guard required safety equipment refer to the U.S. Coast Guard publication CG-290.

**ADDITIONAL RECOMMENDED EQUIPMENT**

In addition to the required safety equipment, we also recommend the following:

Anchor and anchor line	Hand operated bilge pump
Sea anchor	Extra keys
Boat hook	Marine electronics
Fenders (2)	Extra drain plug
Mooring lines (2)	Oar or paddle
Spotlight or flashlight	Insect repellent
Spare fuses	Drinking water
First aid kit	Sun screen
Compass and navigational charts	Bucket and sponge

Tool kit including: adjustable wrench, slip-joint pliers, spark plug wrench and spark plugs, screwdrivers (slotted & Phillips), box end wrench set, hammer, roll of flexible wire, electricians tape, knife, spare propeller & prop nut, and hydraulic fluid.

**BOATING SAFETY TIPS**

The following tips will add to your boating safety and pleasure:

1. Advise someone on shore or the local Coast Guard as to the name of your launch site, your expected direction, and expected return.
2. Watch the weather. You should not attempt to go out when there are storm or small craft warnings. If you are caught in a storm, reduce speed, head into the wind/waves, and keep all gear and passengers close to the center line of the boat for stability. Head for the nearest shelter.

3. Instruct at least one passenger on the fundamentals of operating your boat in case of an emergency.
4. Report any boating accident to the local authorities, whether or not you are involved.

\*\*\*\*\*

#### IN CASE OF AN ACCIDENT

\*\*\*\*\*

If you are involved in a boating accident on the navigable waters of the United States, you are required by law to stop and render assistance. You are also required to identify yourself and your boat to the injured person or owner of the damaged property. If there is more than \$100 in property damage, an accident report must be filed with the proper authorities within five days of the accident. If the accident results in death, disappearance, or injury requiring medical attention, an accident report must be filed within 48 hours. Report forms may be obtained through Coast Guard installations, most harbor patrol offices, and many sheriff and police stations.

\*\*\*\*\*

5. Raise and lower your arms continually if you are having trouble and do not have a radio. Other signals include waving a shirt tied to a pole, repeatedly sounding your horn, flying your boat's ensign upside down, and lighting flares.
6. Keep your boat speed under control. Respect for other boaters and those on shore is common courtesy. In addition, the operator is responsible for any injury or damage caused by the boat's wake. Your wake could swamp or damage a smaller craft and endanger its passengers. Stay alert to areas having signs posted "No Wake Zones".
7. Become familiar with the handling characteristics, capabilities, and limitations of your boat.
8. Turn off engines before swimmers enter or exit the boat. A shift lever in neutral could become engaged accidentally, seriously injuring swimmers.
9. Consult with people familiar with the boating area when venturing into unknown waters. Obtain a chart for new areas whenever possible.
10. Since clean water and air are the responsibilities of everyone, carry a litter container on board and dispose of refuse properly. Become familiar with local laws regarding the discharge of waste.

- 11. Recommend boat shoes or tennis shoes to your passengers rather than street shoes or bare feet.
- 12. Use only United States Coast Guard approved parts or parts that are certified for marine use.

\*\*\*\*\*

**IMPORTANT!!**

\*\*\*\*\*

The fumes from the engine(s) contain carbon monoxide, which may be a health hazard and can be fatal if breathed over a prolonged period of time. Carbon monoxide is a gas formed by the combination of one molecule of carbon and one molecule of oxygen. Chemists refer to it as CO, its chemical formula, "C" for carbon and "O" for oxygen. CO is a colorless, odorless, and tasteless gas. Its weight is about the same as air, so it cannot be expected to rise or fall like some other gases, but will distribute itself throughout space.

Carbon monoxide can accumulate in cabins and under canvas. If your boat is equipped with canvas that encloses the aft cockpit and the propulsion equipment, do not operate the boat with this canvas closed.

A boat operator should be aware that CO is emitted from any boat's exhaust. The operation, mooring, and anchoring in an area containing other boats may be in an atmosphere containing CO that is not of the operator's making. An operator, likewise, needs to be aware of the effect of his actions on other boats. Of prime concern is the operation of an auxiliary generator with boats moored along side each other. Be aware of the effect your exhaust may have on other vessels, and be aware that the operation of other vessel's equipment may affect the carbon monoxide concentration on your vessel.

\*\*\*\*\*

**LOADING CAPACITY**

Though overloading is a primary cause of many boating accidents, improper loading is equally as hazardous. Boaters should not only pay attention to the amount of weight, but also the distribution of weight in the boat.

Near the steering wheel, you will find a metal Coast Guard Capacity Information tag indicating the maximum weight and person capacity of your boat. If you have an outboard model, the tag will also designate the maximum horsepower capacity. You and your passengers will be in jeopardy and your warranty void if any of these requirements are exceeded.



The capacity plate does not relieve the operator from the responsibility of sound judgment. Rough water and adverse conditions can reduce the boat's capacity, so you should maintain a watch on weather conditions.

Example: 208 Adventure  
Capacity Plate

## MAXIMUM CAPACITIES

# 8 PERSONS OR 1130 LBS

2135 LBS. PERSONS, MOTOR, GEAR  
230.0 H.P. MOTOR

THIS BOAT COMPLIES WITH U.S. COAST GUARD SAFETY  
STANDARDS IN EFFECT ON THE DATE OF CERTIFICATION

MANUFACTURER: GRADY WHITE BOATS, INC.

MODEL: 208 ADVENTURE GREENVILLE, NC

DESIGN COMPLIANCE WITH NMMA REQUIREMENTS BELOW IS  
VERIFIED. MFGR RESPONSIBLE FOR PRODUCTION CONTROL

LOAD AND H.P. CAPACITY \* BASIC FLOTATION  
STEERING, FUEL AND ELECTRICAL SYSTEMS  
COMPARTMENT VENTILATION \* MANEUVERABILITY  
NAVIGATION LIGHTS

 NATIONAL MARINE MANUFACTURERS ASSN.



This label found on all Grady-White boats signifies that your Grady-White is certified by the National Marine Manufacturers Association (NMMA). With this tag, you are assured that your fuel system, lighting, ventilation, steering, flotation, capacities, and horsepower ratings are not only in compliance with the U.S. Coast Guard regulations, but also meet the more stringent standards of the NMMA. The NMMA is a national trade organization serving all elements of the recreational boating industry, including

manufacturers of boating equipment. With this tag, you can have confidence in the quality of your boat.

**CERTIFICATION**

Near the steering wheel, on the 243 Chase you will find a Coast Guard certification tag. This tag means your yacht complies with Coast Guard safety standards.

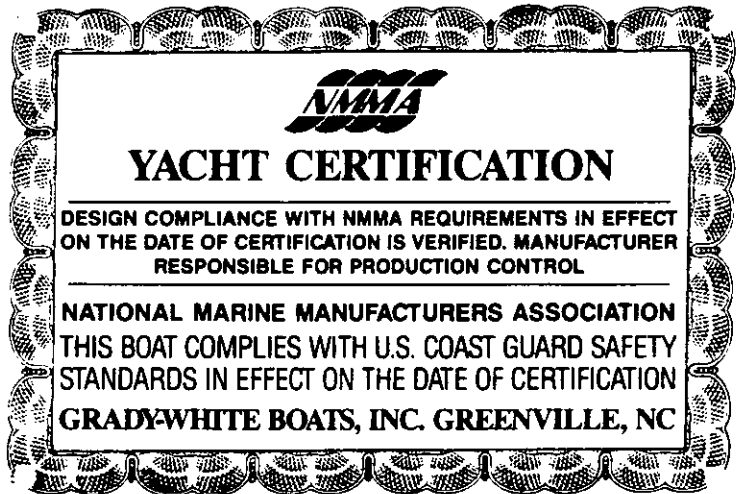

## **GAUGES AND SWITCHES**

Grady White installs full instrumentation on pre-rig and stern drive boats. The instruments are electrically connected to the ignition key and operate when the ignition switch is in the "on" position.

### **INSTRUMENT PANEL**

Not all boats are equipped with the same type of instrumentation. Consult your dealer for information on the type of instrumentation included on your boat.

#### **ENGINE WATER TEMPERATURE GAUGE**

The water temperature gauge indicates the temperature of the cooling water circulating through your engine. When the temperature exceeds the recommended operating range for your engine, immediately shut off your engine to prevent damage. Overheating is often caused by obstruction of your engine's water intake on the lower unit. Check the water intake first if you experience trouble.

#### **FUEL GAUGE**

The fuel gauge indicates the fuel level. When reading this gauge, remember two things: (1) the accuracy of your gauge varies with the attitude of your boat in the water (trim or list), and (2) the fuel pickup tube inside the gas tank is not capable of withdrawing all of the fuel from the tank. For these reasons, never operate your boat at extremely low fuel levels.

#### **OIL LEVEL GAUGE**

The oil level gauge indicates the quantity of oil in the oil tank.

#### **OIL PRESSURE GAUGE**

The oil pressure gauge indicates the oil pressure at the engine. Consult your engine owner's manual for proper operating ranges.

#### **TACHOMETER GAUGE**

The tachometer indicates engine revolutions per minute (RPM's). Consult your engine owner's manual for recommended operating RPM's.

#### **TRIM GAUGE**

The trim gauge indicates the angle of thrust of the lower unit of the engine(s). See the PERFORMANCE section of this manual (page 27) for trim adjustment recommendations.

**VOLTMETER**

The voltmeter indicates the battery charge. A reading of 12 or 13 volts is normal, indicating a fully-charged battery. Readings below 11 indicate a weak battery, which may not start the engine(s). A reading of 13 to 15 volts when the engine is running is normal. Readings over 15 volts may indicate regulator problems. Low or fluctuating readings may indicate loose connections, loose belts, or trouble in the regulator and alternator circuit. A voltage drop soon after the engine is shut down indicates a bad battery or a heavy load on the electrical system.

**WATER PRESSURE GAUGE**

The water pressure gauge indicates the water pressure in the engine cooling system. Readings help determine if water pressure is too low for adequate cooling.

**WATER TEMPERATURE, OIL LEVEL, AND FUEL SYSTEM WARNING BUZZER**

Outboard models may have a warning buzzer, which is located in the throttle control or under the dash. Consult your engine owner's manual for exact location and functions.

**SWITCH PANEL**

At the helm station you will find an accessory switch panel. Not all boats are equipped with the same accessories. Consult your dealer for information on the accessories included on your boat.

**BATTERY SELECT**

Boats that are equipped with two batteries use select switches to indicate which battery will be used. The select switch(es) are labeled Battery 1, Battery 2, BOTH, and OFF.

If operating a boat with one select switch, choose a battery to start the engine by selecting #1 or #2. Only select BOTH when neither of the batteries is able to start the engine and it is necessary to combine the power of both batteries. Once the engine has been started, return the switch to the #1 or #2 position so that battery may be charged.

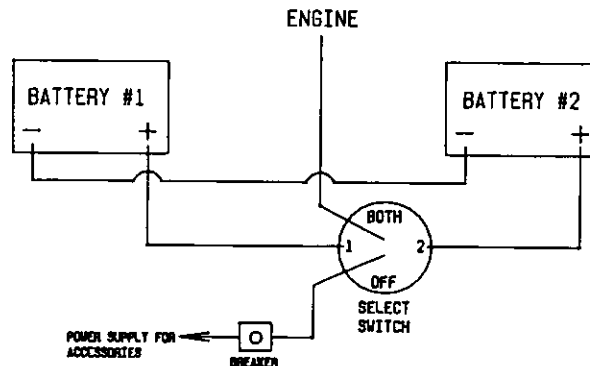

On twin engine boats with two select switches, a switch should be connected to each engine. Either engine may be started by either battery by selecting battery #1 or battery #2 on the switches. In normal use, select battery #1 on one switch and battery #2 on the other so that both batteries will be charged equally.

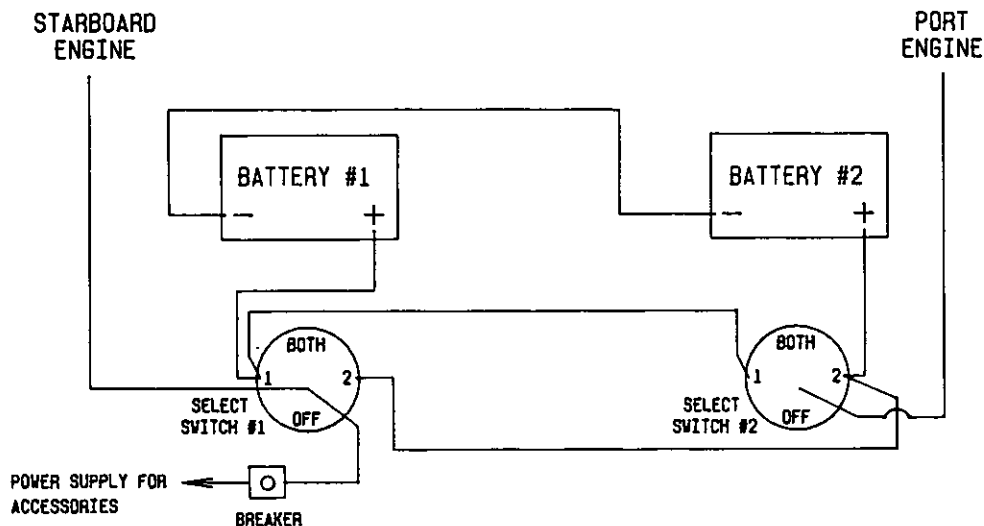

In an emergency situation, when neither battery will start the engines, the select switches allow you to combine the power of both batteries by selecting BOTH. The switches must be returned to either the #1 or #2 position after the engines are started to allow each battery to be charged.

**WARNING:** Never turn the battery select switch to OFF with the engine running as this could damage the charging system.

#### **BILGE PUMP**

This two-way switch serves as an overriding manual switch in the event of failure of the automatic switch in the bilge.

#### **BLOWER**

The blower eliminates any gasoline fumes from the engine compartment on stern drive models. It should be run at least four minutes before starting the engine and should be in operation when running slower than cruising speed.

#### **COCKPIT LIGHTS**

The cockpit lights provide illumination for the cockpit area.

#### **FUEL**

When there are dual tanks, a three-position switch (MAIN-OFF-AUX) gives you separate readings for each tank.

**HORN**

The horn meets the requirements of the United States Coast Guard's emergency sound signal device.

**LIVWELL**

The livewell system may be either standard or optional. Some boats may combine the livewell and washdown switches.

**NAVIGATIONAL/ANCHOR LIGHTS**

All models are equipped with lights that meet international lighting regulations. The three position switch (NAV-OFF-ANCHOR) changes the lighting configuration to running or anchor lights.

**TRIM/TILT**

The trim/tilt switch is located in the throttle control. Some stern drive models, however, may have a separate tilt switch located on the dash. Trim changes the angle of thrust of the engine (see PERFORMANCE section, page 27). Tilt raises the drive unit for trailering.

**TRIM TAB**

Trim tab switches control the trim tabs used for adjusting the attitude of the boat. (see TRIM TABS, page 28).

**WASHDOWN**

This switch activates the washdown system. Some boats may combine the washdown and the livewell switches.

**WATER PRESSURE**

This switch activates the pressurized fresh water system.

**WINDSHIELD WIPER(S)**

This switch activates the windshield wiper(s).

**ACCESSORY**

Switches labeled "Accessory" are blank switches, and fuses labeled "Accessory" are blank fuses. Both are used for non-factory installed accessories.

NOTE: Most accessory switch panels have indicator lights and fuse holders for each switch. (See page 40, for recommended fuse amperages). Switch identification labels are available from your dealer for non-factory installed options.

**AUXILIARY FUSE PANEL**

The auxiliary fuse panel, located under the dash, offers the ability to connect additional electronics in excess of the accessory switches located in the dash. All models have the same auxiliary fuse panels, except for the 192 Tournament, 208 Adventure and the 209 Escape. These models have a fuse panel that utilizes automotive type fuses (Figure A). All other models utilize glass fuses (Figure B).

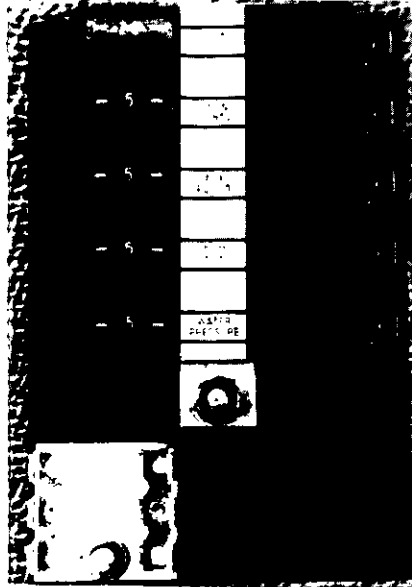
**FIGURE A****FIGURE B**

## STEERING

### MECHANICAL STEERING

All Grady-White boats that utilize mechanical steering are equipped with No Feedback Mechanical Steering. No Feedback Mechanical Steering provides easier steering and increased accuracy by compensating for engine torque.

NOTE: All stern drives are equipped with No Feedback Mechanical Steering. Stern driven autopilots cannot be utilized with No Feedback Mechanical Steering.

The mechanical steering system is designed to require a minimum of maintenance; however, you should periodically inspect the steering system (especially the control heads, cable ends, and attachments) for wear, rust or corrosion, and lubricate the parts when needed. If you ever notice any change in the "feel" of the system, such as binding, looseness, noise, or sticking, immediately perform a thorough inspection.

On outboard models, the push rod at the end of the cable is susceptible to freezing if improperly greased. When the boat is not in use, the motor should be turned so that the push rod is not exposed to the elements. If you operate in salt water areas, lubrication is extremely important and you should make frequent inspections for corrosion.

### HYDRAULIC STEERING

Hydraulic steering systems (not to be confused with power steering) require regular preventative maintenance for continued safe and reliable operation. The oil level in the helm pump must be maintained within acceptable operating levels. A low oil level will cause air to be introduced into the steering system and result in unresponsive steering. The oil level should always be within 1/2 inch from the base of the fill hole, located on the front top portion of the helm pump. Check the steering system for oil leaks. An unchecked leak, in time, will result in unresponsive steering and/or possible loss of steering.

All moving mechanical linkages, sliders, etc. must be greased as needed with a high quality marine grease.

Refer to steering manufacturer's owner's manual for specification recommendations and additional maintenance requirements.

Any slow or sudden change in the "feel" of your steering system indicates an immediate need for a thorough inspection. All repairs and replacements to steering systems should be made only by an authorized dealer.



**TILT STEERING**

Tilt steering is available on certain models in conjunction with hydraulic steering. This feature enables the operator to tilt the wheel up or down. Refer to steering system's owner's manual for information on oil levels with tilt steering.

## BOAT OPERATION

### FUELING

Safety during fueling requires common sense and caution. Please study the following procedure carefully, and ask your dealer if there is doubt about any procedure.

1. Check your engine owner's manual to make sure that you only use on the type of fuel specified by the manufacturer. Do not use gasoline containing alcohol. If you operate an outboard with an oil injection system, check the engine manual for the recommended type of oil and fill the oil tank completely.
2. Close all ports, hatches, windows, and engine compartments before fueling, in order to prevent gasoline fumes from accumulating.
3. Stop all engines, motors, and fans (including bilge pump), and turn off lights before fueling.
4. Extinguish all cigarettes and other lighted materials.
5. Keep the fuel supply nozzle in contact with the fuel tank opening in order to prevent a static spark.
6. Observe fuel flow at all times to prevent overflow or spillage.
7. Secure the fuel cap after fueling and ventilate all ports, windows, hatches, engine compartments, and closed areas.
8. Wash down and clean off any spilled fuel. Dispose of any rags, sponges, etc. used for clean-up. Do not carry these items on board.
9. Keep the fuel tank as full as possible, especially during storage, as condensation can develop and result in water in your fuel system.
10. Check for gas fumes in the engine compartment (on stern drive models) before starting, and run the blower at least four minutes or until all fumes are eliminated.

11. Select your first tank carefully (if your boat is equipped with two fuel tanks), taking into consideration the distribution of your load as fuel is consumed. Performance will be affected by the weight distribution in your boat.
12. Remove the gas tank compartment drain plug (on stern drive models only) periodically to drain any water which may accumulate in this area. The drain plug is located in the aft bilge compartment on the starboard side of the keel line drain tube.

### FUEL SYSTEM MAINTENANCE

If you are experiencing fuel flow problems, an easy method of determining if the problem is in your fuel system is to connect a six gallon portable tank to your engine. Also, inspect the anti-siphon valve (pictured below) to make sure fuel is flowing properly. The manual shut off valve should be closed when servicing the fuel system to avoid spilling fuel into the bilge.

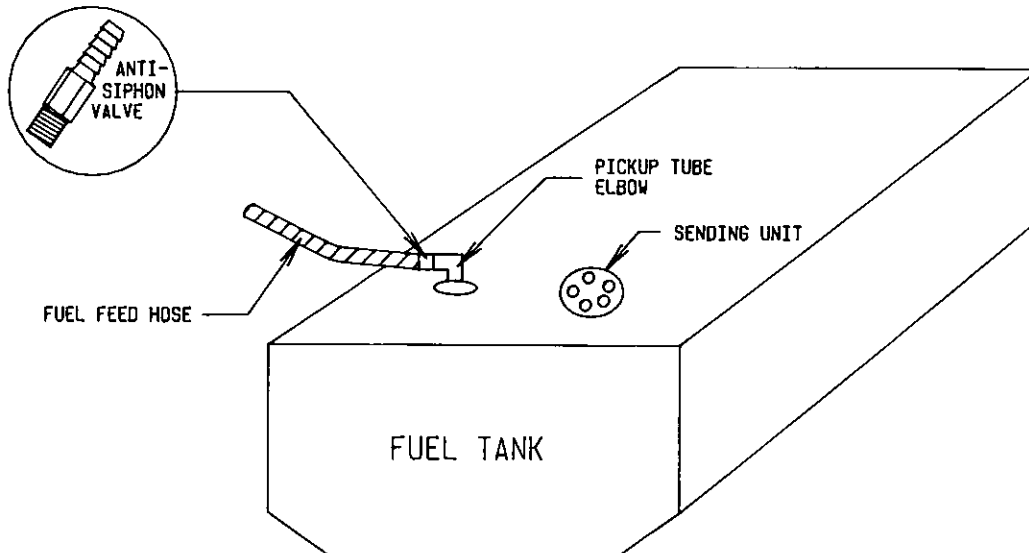

Do not use fuels containing alcohol. Alcohol, particularly methanol, will absorb water, which makes fuel more corrosive to metals in tanks and carburetors, and shortens the life of elastomers, such as hoses and gaskets.

After fueling, inspect the fuel lines, connections, and fuel tanks for tightness, signs of leaks, and deterioration. At least annually, conduct a more thorough inspection of fuel system components, especially those hidden from routine inspection. Replace any deteriorated hoses, clamps, connections, or fittings.

## TRAILERING

The adjustment and balance of your boat on your trailer determines how easily your boat may be transported. Swaying while trailering is usually caused by a tail-heavy load. The tongue weight on the hitch ball should be 5-10% of the total weight of your boat, motor, and trailer. The rollers and/or bunkers of your trailer should be adjusted so that the weight is distributed evenly across the stern and forward throughout the keel section. Your dealer should be responsible for adjusting your trailer properly.

Check the following prior to trailering your boat:

1. Hitch is tight and secure.
2. All nuts and bolts are securely tightened and the safety chain properly secured.
3. Winchlocks and tilt mechanism in correct positions.
4. Tires (including spare) are properly inflated and in good condition.
5. Signal, stop, and other lights operating properly.
6. Gear on boat is properly secured for travel.
7. Tie down straps are secure.
8. Wheel bearings properly greased (each year).
9. All cabin windows and doors secured.
10. All canvas tops and side curtains are taken down and secured to prevent wind damage/loss in transit.
11. All lines are properly secured.
12. Mooring cover removed. (Damage to canvas during transit is not covered in warranty).

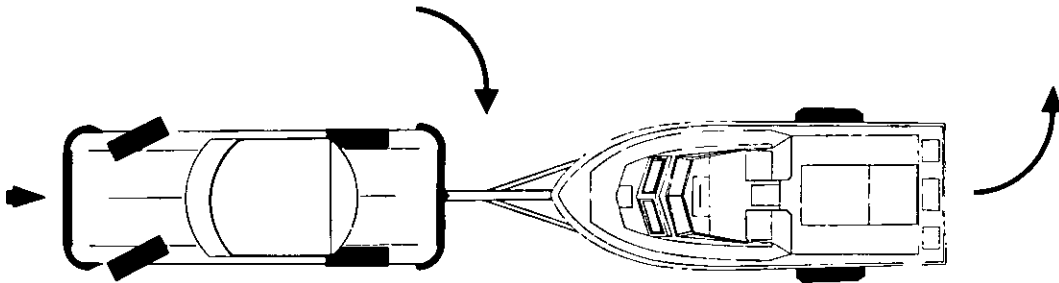

**BACKING TO RIGHT**

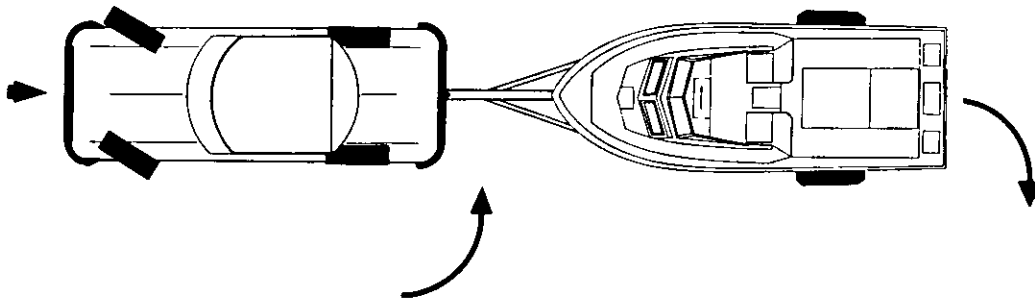

**BACKING TO LEFT**

## LAUNCH AND RECOVERY

### **LAUNCHING**

Prior to initial launch, familiarize yourself with this manual and all aspects of your boat. At the launch site, go through a pre-launch check list. The check list should be suited to your particular needs, but the following items should be included:

1. Make sure the drain plug is in place.
2. Attach a launch rope.
3. Make sure the proper safety equipment is on board.
4. Tilt engine or drive unit to the "up" position.
5. Remove the tie down strap.
6. Close the engine drain and freeze plugs.

After the pre-launch check, back your trailer slowly into the water, preferably keeping the axle hubs above water (unless your trailer is a submersible model). Set the hand brake of your car and place chocks under the rear wheels. Attach a bow line to the boat, release the winch cable, and give the boat a firm push. When the boat is clear of the trailer and secured to the dock, move the trailer to the parking area.

### **PRE-START CHECK LIST**

1. Check the bilge for excess water and leaks.
2. Turn on the bilge pump to remove any excess water, and leave the pump on stand-by.
3. Turn on the bilge blower (on stern drive models) and check for leaking fuel or fumes. Run the blower at least four minutes prior to starting.
4. Check engine oil level, battery cable connections, electrolyte level, and all drive belts for wear and proper tension.
5. Check steering for freedom of movement.
6. Make sure navigation lights are in working order.

### **STARTING**

1. Lower the drive unit to the "down" position. Be sure the propeller is free of any obstruction.
2. Set the control lever in the neutral position. Engage the neutral lock out button in the control handle and pump the control throttle forward 2 or 3 times.
3. Set control throttle slightly forward of straight up and turn the ignition key to start.
4. Check all instruments. If the oil pressure gauge does not respond immediately, shut off the engine.
5. Test steering and throttle response at the dock.

**RECOVERY**

1. Secure the boat to the dock or boarding platform.
2. Make sure all equipment has been unloaded and all people are off of the boat.
3. Back trailer into position in the same manner as launching.
4. Use the bow line to maneuver the boat into position for loading.
5. Load and secure the boat onto the trailer.
6. Move the trailer and boat away from the ramp and remove the drain plug to allow water to drain from the boat.
7. Complete cleanup and other precautionary measures before towing.

**ANCHORING**

The size of your boat and the type of lake, sea, or river bottom in your boating area should determine the size and type of anchor. The anchor line length should be 4 to 7 times the depth of the water. Increase this length in strong winds and currents.

A 3 to 4 foot length of chain between the anchor and the anchor line will help prevent the line from chaffing on rough obstacles below the surface and will also help hold anchor flukes down for more secure anchoring.

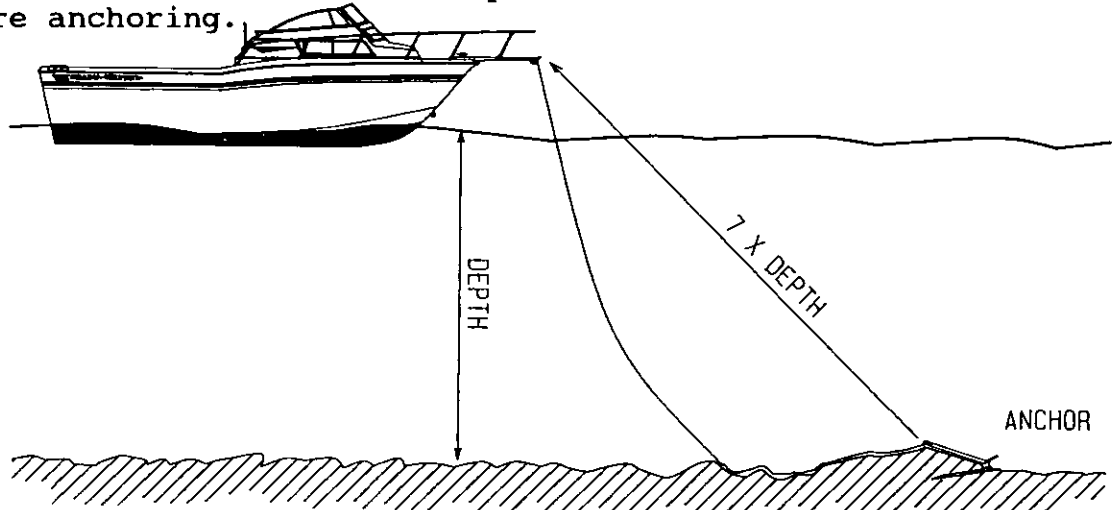

To anchor, head the boat into the wind or current to stop the forward motion. Make sure your anchor line is secured to a cleat and runs under the bow rail. Lower the anchor into the water until it reaches the bottom. Feed out the anchor line slowly as the wind or current forces the boat backward. Reverse engine if necessary. Before stopping engines, make sure anchor is secure.

To retrieve the anchor, slowly drive the boat to the point directly above the anchor and pull upward on the anchor line until anchor is retrieved. If the anchor is difficult to raise, tie off the anchor line while directly over the anchor and slowly motor forward to "free" the anchor from the bottom.

Even while anchored, your boat will swing with the wind, so do not anchor close to other boats or objects. In addition, remember that it is illegal to tie your boat to navigational aids, such as buoys and markers.

**WARNING:** Never anchor off the stern of the boat, especially in strong winds or currents. The weight of the stern and flat surface to the seas can easily cause water to enter over the transom, and swamp the boat.

### DOCKING

Unlike an automobile, the stern of your boat reacts first when turning. A turn to the right will swing the stern to the left and vice-versa. Remember that turning your boat away from an object, such as a dock will tend to swing the stern toward that object.

Before bringing your boat to the dock, consider the wind and how it may be used to your advantage. Approach the dock at a 30 to 45 degree angle at a slow speed. Before the bow reaches the dock, shift the engine to neutral, turn the steering wheel toward the dock, and shift the engine into reverse. The boat will slow and the stern will swing toward the dock.

When pulling away from the dock, push the stern clear of the dock to make sure you have enough room to maneuver. You can then get underway without bumping the stern against the dock.

Slowing and stopping your boat requires some practice. The length of time required to come to a complete stop will vary with wind and current. Judging the distance and momentum of the water is a skill that improves greatly with practice.

### THROTTLE/SHIFT CONTROL

The throttle/shift control, located at the helm station, controls the flow of fuel to the engine and acts as a gear shift lever to control the forward and aft thrust of the propeller.

The vertical position of the throttle control is normally the neutral position. Move the control forward to engage the shifting mechanism, which creates a forward thrust of the propeller. Increase the forward movement to increase the fuel flow to the engine and increase the forward thrust.

Move the control lever aft of the neutral position to reverse the shift mechanism and create a reverse thrust of the propeller. Increase the aft movement to increase the reverse thrust. Remember that propellers are designed for maximum forward thrust, so reverse thrust will not be as efficient.

All controls have a safety mechanism that does not allow the engine to start when the control is in gear. In order to increase the flow of fuel to the engine while remaining in the neutral position, you may use the neutral lock out button in the control handle.

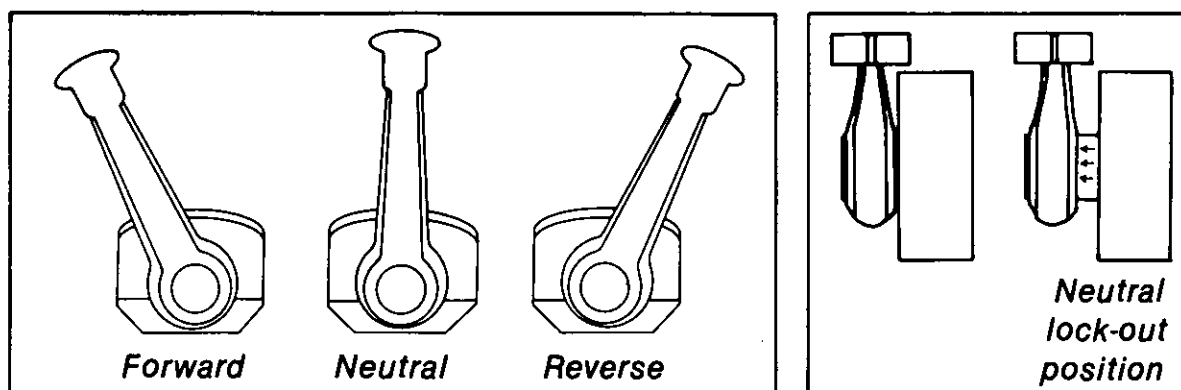

As the boat is moving forward, you may reverse the shift mechanism that will provide a "braking action", slowing the boat.

**CAUTION:** THIS BRAKING ACTION CAUSES A FOLLOWING WAKE WHICH MAY RISE ABOVE THE TRANSOM AND FLOOD THE BOAT IF THE BOAT IS MOVING AT TOO GREAT A SPEED. ALLOW ENGINE RPM'S TO DECREASE BEFORE SHIFTING INTO REVERSE.

The control head at the helm should be cleaned and kept free of corrosion. Periodically check the mounting for loose screws. Also check the cable conduit for cracks, abrasions, or kinked or bent cable. See your dealer to replace damaged cable.

The cable ends and cable fittings should be checked periodically for corrosion, loose brackets and loose, worn, or damaged fittings. Replace worn or damaged parts. Cable ends, fittings, and the control mechanism may be sprayed with a moisture displacing lubricant. If your control has "quick disconnect" fittings, inspect the springs for corrosion. Should your throttle or shift cables need replacing, the data sheet at the front of this manual will indicate the lengths required.



## PERFORMANCE

Maximum performance is only obtained when your hull bottom is clean. Detailed recommendations for hull cleaning are included in the MAINTENANCE section (page 31).

Assuming your boat is equipped with the correct engine, the engine is properly tuned, and the drive system is in good condition, poor boat performance is usually traced to improper trim settings, the wrong propeller, or improper load distribution.

### TRIM

Stern drive models and many outboard models are equipped with power tilt and trim mechanisms. The purpose of the tilt is to raise the engine for launching, loading, or trailering your boat.

Trim refers both to the weight distributions inside the boat and to the angle of thrust of the drive unit. The angle of thrust of the drive unit either forces the bow up or down. A drive unit tilted too far in (forward) will cause the bow to nose downward or "plow". A drive unit tilted too far out (aft) will cause the bow to ride too high. Adjust the trim so that the angle of thrust is parallel to the water at full throttle at a normal running attitude.

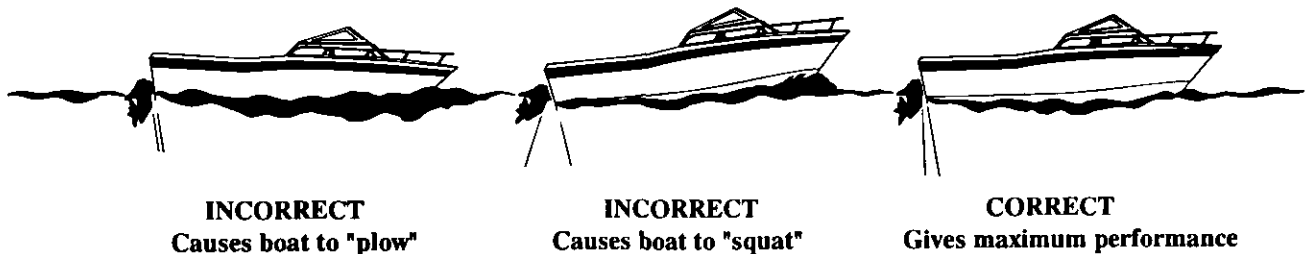

When the angle of thrust is too far out (aft), the engine noise may rise indicating that the propeller is cavitating. Adjust the engine trim in (forward) to correct the problem. The boat may also tend to "porpoise" in maximum bow up position as well. This can be corrected by adjusting the engine trim in and trimming the bow down.

For a smoother ride when running into heavy seas, the bow should be adjusted so that the entry point into the water is slightly forward of the helm location. When running in a following sea, the bow should be trimmed higher to prevent the boat from plowing into the seas. As sea conditions change, experiment with the trim to find the best performance for your particular boat and load.

### TRIM TABS

Trim tabs are electrically-hydraulically operated and are used to regulate the attitude of the boat while moving. They may also be used to adjust the boat's running angle in adverse seas or to compensate for unusual load conditions.

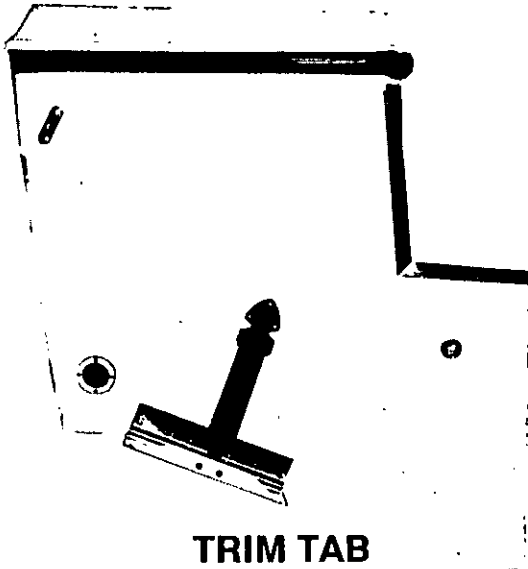

**TRIM TAB**

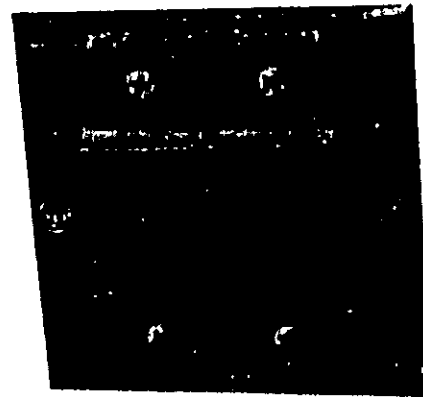

**TRIM TAB SWITCH**

The trim tabs are operated by a two rocker switch panel and will aid in trimming the boat fore and aft for a smoother ride. The switches are marked "bow down". Trim tabs in the extreme "bow up" positions will have no effect on the boat's ride.

Trim tabs can improve the ride of your boat by adjusting where the water is hitting the keel line. In a slight chop, the waves may be hitting the keel of your boat around the helm area, causing an uncomfortable ride. By adjusting the trim tabs and lowering the bow, the waves will hit the keel at a more forward point, softening the ride. Experimentation with trim tabs in various sea conditions will help you determine the best positions for your boat under different load conditions.

Trim tabs are also useful in correcting a port or starboard list. If the boat is listing to the port side, press the starboard trim tab switch toward "bow down". Press the port trim tab switch toward "bow down" to correct a starboard list. This will tend to lower the bow by pulling the higher side to a level position. If your bow is already in a low position, you may correct list by pressing the trim tab switch toward "bow up." This will cause the low side to rise and level the boat. It will also gradually improve the running angle.

Trim tabs in the extreme "bow down" position will cause the boat to come on plane with minimum bow rise. Unless you are operating at low speeds or with considerable cockpit weight, you will likely want to raise the tabs slightly when underway in order to avoid "plowing" water. With the tabs in the "bow down" position, you will be able to maintain a plane at the least possible RPM's.

\*\*\*\*\*

**IMPORTANT**

\*\*\*\*\*

Most drive units are equipped with an adjustable rudder trim tab. This trim tab should be adjusted to balance the steering at the speed which you travel most frequently. Variations in speed, boat load, or changes in the drive unit trim will cause the steering to pull in one direction. If the boat pulls to the left, adjust the trim tab to the left and vice-versa.

\*\*\*\*\*

**TRIM TAB PUMP LOCATIONS**

**25 DOLPHIN**

Trim tab pump is located in the starboard berth storage compartment.

**243 CHASE**

Trim tab pump is located in the console rigging compartment

**24 EXPLORER**

Trim tab pump is located in the starboard berth storage compartment.

**23 GULFSTREAM**

Trim tab pump is located in the starboard berth storage compartment.

**22 SEAFARER**

Trim tab pump is located in the starboard berth storage compartment.

**22 TOURNAMENT**

Trim tab pump is located in the forward starboard storage compartment.

**208 ADVENTURE**

Trim tab pump is located in the starboard berth storage compartment.

**209 ESCAPE**

Trim tab pump is located underneath the center console.

**NOTE:** Trim tabs are optional on the 22 Seafarer, 225G Tournament, 208 Adventure, and 209 Escape.

### PROPELLER

The condition of your propeller is a major influence on the performance of your boat. Your engine is equipped with the best size propeller for normal conditions. If you have unusual uses or weight conditions, you may require different propellers for different applications. It is advisable to keep an extra propeller on board. A damaged propeller can affect your boat's top speed, cause vibrations or a sudden drop in RPM's, or increase fuel consumption.

**CAUTION:** When replacing propellers, make sure you stay within the engine manufacturer's maximum and minimum RPM ranges. This information is in your engine owner's manual. If your boat does not have a tachometer, consult your dealer for propeller changes.

Cavitation occurs in all propeller driven boats under certain conditions. It is easily recognized by sudden increases in RPM's (revving) or a sudden drop in speed. This occurs when cavities, or air pockets, form around the propeller. Cavitation is influenced by propeller design, speed, placement, and even water temperature. In most cases, a change in the drive angle (trim) will correct the problem. If the problem persists, you will need to experiment with different size propellers.

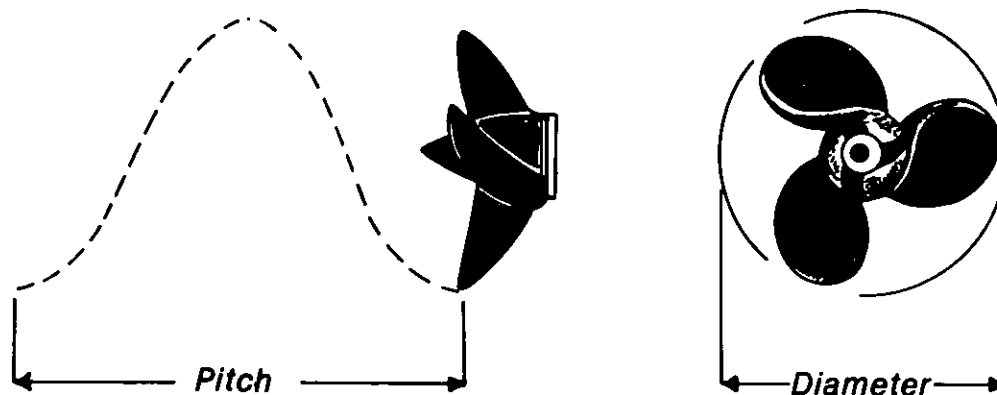

### LOAD DISTRIBUTION

The performance of your boat is directly affected by the distribution of weight on board. Be aware of the distribution of gear, passengers, and fuel.

## MAINTENANCE AND SERVICE

Your hull and deck are constructed by the hand lay-up method using the highest quality fiberglass mat and woven roving. This method of construction insures a proper fiberglass-to-resin ratio and a uniform thickness, which together result in a much stronger boat than those constructed of "chopped glass". This is an expensive process, but insures that your Grady-White is the strongest, most durable fiberglass boat possible.

Proper maintenance of your boat is not only a source of pride but is the key to maintaining your boat's value. A few simple steps will keep your fiberglass Grady-White looking showroom bright for years.

### FIBERGLASS FINISH

The exterior, or gelcoat, of your Grady-White is a thin layer of resin with a finished color pigment. It is used for cosmetic purposes and makes routine maintenance relatively simple.

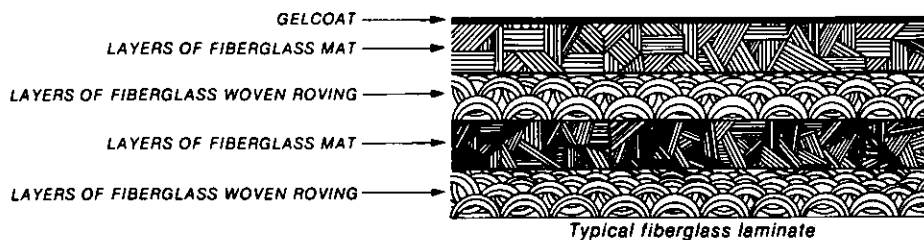
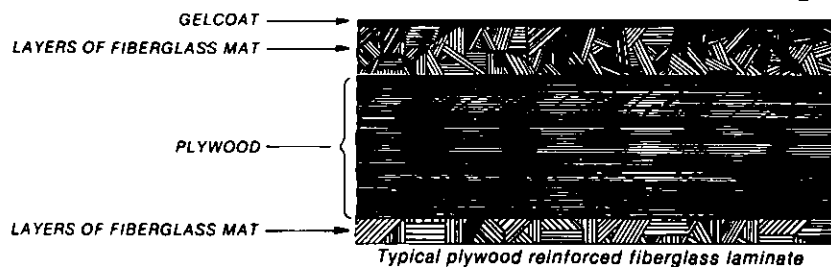

The gelcoat of your Grady-White is the finest available. The best method of cleaning the boat is with a mild household detergent and plenty of fresh water. A coat of wax (either automobile or boat wax will do) will maintain the smooth, glossy finish and protect the boat's surface. **Do not** wax surfaces that may be walked on, as they will become quite slippery.

Though gelcoat is a very durable material, it can still be subject to scratches, blistering, and web-like cracks (crazing) over time. It is elastic enough, however, to withstand strong blows while flexing with the hull's movement. Gelcoat problems are cosmetic and will not affect the structural integrity of your boat.

If you leave your boat in the water for more than a few days at a time, the bottom of the boat below the waterline should be painted with anti-fouling paint to protect it from marine growth, barnacles, and blistering, which inhibit performance. Since anti-fouling paint slowly dissolves to prevent marine growth, inspection and cleaning of the boat bottom at least once per season is advisable. Repaint whenever necessary.

### GELCOAT

Many gelcoat imperfections can be repaired using the following procedure:

1. Obtain the original colored gelcoat from your dealer and a small amount of M.E.K. (catalyst), which when mixed with the gelcoat will cause it to harden. You may also wish to obtain acetone, which is the most suitable cleaning agent for gelcoat. If painting with gelcoat in a bilge area, a surfacing agent should be used.

**WARNING!** M.E.K. (Methyl ethyl ketone peroxide), gelcoat, and acetone are flammable and hazardous if not handled properly. Follow instructions on the containers carefully. After the gelcoat is catalyzed, it may become hot in the mixing container and catch on fire. Before disposal, submerge gelcoat in water until cool.

2. If the surface to be repaired is flat, lightly sand this surface (removing all glossy areas) so that the new gelcoat will adhere to the surface. If the area to be repaired is cracked, the crack should be routed out with a small instrument. To protect surrounding areas, apply tape around the area to be repaired. Any crack extending past the gelcoat surface and into the fiberglass will need a more extensive repair. We suggest you consult your dealer for additional instructions.
3. A small amount of gelcoat should be tested with the catalyst before mixing the material for your repair. You will then be able to understand how the chemicals react. Pour approximately 1/2" of gelcoat into a small cup with approximately 1.5% M.E.K. (about 3 to 5 drops) and stir thoroughly. Spread a small amount of the mixture on a test surface and measure the time it takes to harden. Hardening time should be from 15 to 45 minutes. Too little M.E.K. will lengthen the hardening time. Too much M.E.K. will cause the patch to become rubbery and cure improperly. It is best to be under catalyzed. When you obtain the proper mixture in a test, use the same ratio of M.E.K. to gelcoat for your actual repair.

4. Apply to the defective area using a small stick (a medical tongue depressor or popsicle stick works well). The mixture should be applied in a thin layer, bringing the patch up to the level of the original surface. Too much material will require extra sanding.
5. When the patch has hardened, any raised area should be sanded carefully with 220 grit sandpaper bringing it level with the original surface. As you approach the finished surface, use 400 or 600 grit sandpaper that has been dampened with water. The water will reduce scratching. Wrapping the sandpaper around a small block of wood will help keep the sanded area level.
6. Remove the tape around the patch and you will notice that it has a dull finish. Any good automotive buffing compound applied with a power buffer will bring a luster to the surface.

#### INTERIOR

Your interior vinyl upholstery may be cleaned with a mild solution of household detergent and fresh water. Commercially available cleaners for vinyl also work well. Be sure to follow the instructions on the label.

Most cabin cushions are removable and may be dry cleaned. Some cabin cushions are of a Herculon-type fabric and may be cleaned with upholstery cleaner. DO NOT MACHINE-WASH THESE FABRICS.

Since the seams of your upholstery are not water proof, your upholstery should be stored in the cabin or covered when not in use. Lounge seat bases, which are constructed of exterior fir plywood, should be ventilated when the boat is not being used.

#### CANVAS

Follow these steps to maintain your boat's top and other canvas:

1. Wash canvas periodically with a heavy-duty detergent and warm water. Do not use petroleum-based or ammonia cleaners on canvas or clear vinyl as they will yellow.
2. Lubricate the snap buttons and zippers with petroleum jelly or paraffin.
3. Clean clear vinyl thoroughly with denatured alcohol, and then apply a protective layer of clear wax. Do not use paste wax as it will turn vinyl yellow. This process should be repeated as necessary to maintain the protective wax coating.

4. Store and secure canvas before trailering.
5. Dry all canvas before storing to prevent mildew.
6. Remove the top, front, and side panels and roll them up for storage. This procedure is necessary to prevent the front and side vinyl pieces from cracking. NEVER FOLD THESE PIECES!

Though your Grady-White boat's canvas is made using the highest quality vinyl and latest sewing techniques, your boat's canvas will not be completely leak proof. The seam holes in your canvas may stretch and tend to leak. However, you can correct much of this problem by applying paraffin over the seams.

Please understand that Grady-White does not warrant the fit and design of the canvas to be completely watertight.

#### DURATRIM

In the cockpit areas of your boat, duratrim is used for trim work. This material has an appearance similar to teak, but requires almost no maintenance. Maintenance of your duratrim should include regular cleaning with soapy water and an application of a surface protector once or twice per season. Never sand your duratrim!

#### HARDWARE

Even though your hardware is made of laboratory grade 316 stainless steel, it needs regular cleaning to maintain its "less staining" properties. Use a mild solution of soap and water to clean your stainless after using your boat. If a stronger solution is needed, add a small amount of vinegar to the soap and water.

Stains and discoloration may be removed with a non-abrasive metal cleaner. You should **NOT** try to remove stainless steel stains with an acidic solution, such as a household cleaner. In fact, where acid rain is a problem, you should rinse your boat with fresh water after each rainfall.

The key to maintaining your stainless steel is to keep it clean. Try to remove all salt or dirt from your stainless on a regular basis. Also, remember to rinse your hinges on baitwells and fishboxes regularly. In addition, to avoid sticking and rusting, hinges may need a small amount of penetrating oil.



### ENGINE

If your Grady-White is powered by a stern drive engine, refer to the engine manufacturer's manual for maintenance procedures. Complete the engine warranty card and forward it to the manufacturer. If your boat is outboard-powered, your dealer should provide an engine owner's manual to help you with routine maintenance.

### GRADY DRIVES

Since there is a chance of moisture entering the engine bracket, a drain has been provided. Any moisture entering the bracket should drain to the bottom. The drain plug should be removed periodically to drain the bracket.

The Grady Drive is made of aluminum; therefore, it is very important to use the appropriate type of bottom paint. Consult a bottom paint specialist or your Grady-White dealer for advice on the type of paint to use.

### SCUPPERS

All Grady-White boats have self-bailing cockpits, meaning that water on the cockpit floor drains through overboard drains rather than into the bilge. The stern drains (scuppers) have an external scupper flap assembly (as shown below), which restricts the flow of water back into the boat. Inspect the flaps periodically to make sure that they are free of debris. The scupper flaps will need periodic replacement.

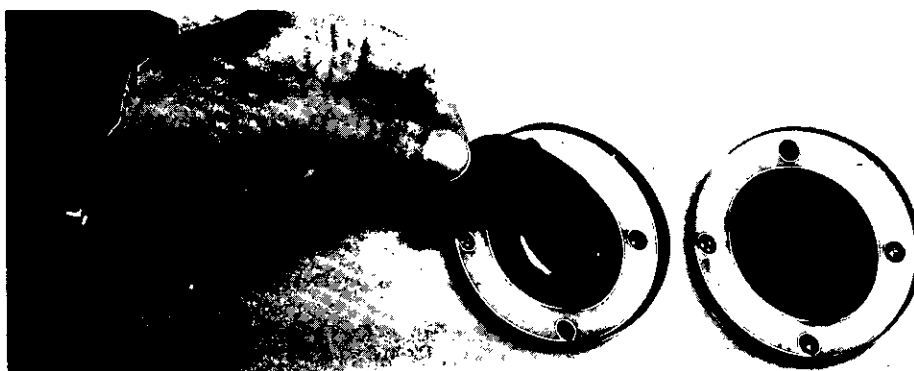

### HARDWARE MOUNTING

When drilling mounting holes in boat surfaces, make sure each hole is sealed properly. Sealing will prevent water leakage, which is especially important in fiberglass areas that have been reinforced with plywood. A hole sealed improperly allows water inside the fiberglass, which leads to saturation of the plywood reinforcement.

**BATTERY**

Regardless of the type of power your boat uses, your battery(ies) are extremely important. They should be secured in a non-metallic tray to avoid electrolyte spills, and battery terminals should be covered by an insulated boot.

Check the fluid level in each battery cell at least once a month. Fill the battery to the upper level with distilled water. Never overfill the battery.

Keep terminals clean by scrubbing them with a stiff brush and a mixture of baking soda and water. Afterwards, apply a light coat of grease. Be careful not to let any of the baking soda/water mixture enter the battery.

When not in use, check the battery each month by using a battery hydrometer, which measures the specific gravity. The meter should read between 1250 and 1280.

**CAUTION:** Never disconnect the battery when the engine is running as damage to the charging system could result.

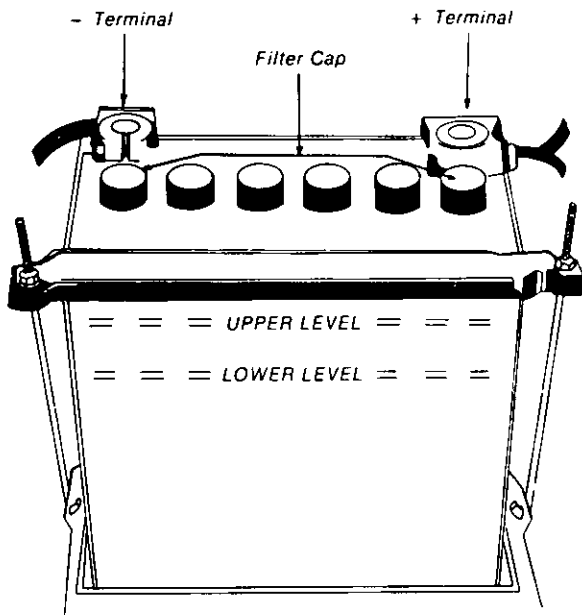

*The battery contains sulfuric acid. Avoid contact with skin, eyes or clothing. Antidote: EXTERNAL — Flush with water. INTERNAL — Drink large quantities of water or milk. Follow with milk of magnesia, beaten egg or vegetable oil. Call physician immediately. Eyes: Flush with water and get prompt medical attention. Batteries produce explosive gases. Keep sparks, flame, cigarettes away. Ventilate when charging or using in enclosed space. Always shield eyes when working near batteries.*

**KEEP OUT OF REACH OF CHILDREN.**

\*\*\*\*\*  
 Remember, when disconnecting and reconnecting battery cables that the black cable must be connected to the negative terminal, and the red cable must be connected to the positive terminal of the battery. Reversing this procedure will immediately damage your system.  
 \*\*\*\*\*

**230 GULFSTREAM RIGGING COMPARTMENT**

The 230 Gulfstream has a rigging compartment located aft of the gas tank compartment. This compartment is functional for rigging oil tanks or ignition protected pumps. A subfloor has been installed at a height that will allow easier access to the oil tank filler caps through the six inch inspection port.

**WARNING:** This compartment should NOT be used for batteries or portable fuel tanks as this compartment is not sufficiently ventilated.

The rigging hatch and mounting screws must be sealed with silicone sealer after rigging is complete. If the lid is removed, it must be resealed to insure watertight integrity.

## WINTERIZATION AND STORAGE

If your boat is out of use for the winter or an extended period of time, special attention should be paid to areas that may be damaged by freezing temperatures. Even if you live in a warm climate, you should inspect your boat on an annual basis.

The winterizing check can be done by a knowledgeable boat owner but preferably by a professional with a competent staff of technicians at your Grady-White dealership. Either way, the following checklist is a good place to start:

1. There are detailed instructions in your engine owner's manual regarding the procedures for winterizing the engine. Follow these important instructions carefully and your engine should survive the most severe weather conditions. Change all filters, check hoses and clamps. If you have developed any vibrations during the season, look for loose engines, bent shafts, or bent propellers.
2. Clean and wax your boat before storage. If you store your boat in the water, there may be a layer of growth on the bottom in addition to the anti-fouling paint. As it dries, this debris will harden, so scrub the bottom immediately after the boat is removed from the water.
3. Raise and block the trailer axle to prevent tire deterioration. This is an excellent time to lubricate and pack the wheel bearings per manufacturer's instructions.
4. Drain all tanks, water lines, and pumps to prevent freeze damage. The fresh water system may be drained by running any faucet until the tank is empty. When empty, turn the faucet off to prevent pump damage. Residual water will not damage the tank. If desired, the fresh water system may have a nontoxic antifreeze added. This antifreeze can be purchased at most marine dealerships or camping dealers. To drain other lines, close seacocks and run the pumps until the lines are dry. In warmer climates, draining will help prevent water stagnation.
5. Remove the bilge drain plug and open all valves and seacocks to keep the bilge dry. Store your boat with the bow elevated to help drainage.

6. Make sure your fuel does not contain alcohol, keep your fuel tanks full during storage or periods of infrequent use to prevent condensation of water vapor and subsequent engine malfunction. There are also additives available to inhibit condensation. Fuels containing alcohol will absorb humidity, and the resulting condensation will separate from the fuel as the temperature drops during winter months, causing corrosion. This is a good time to have your fuel filters changed, if they have not been changed recently.
7. Check the electrolyte level in your battery and fully charge the battery before storing. A weak battery loses its charge more rapidly than a strong battery. Ideally, you should disconnect the batteries and cover the terminals with grease to prevent corrosion. Store the battery in a cool, dry area on a wood board. Do not store your battery on concrete, because the cold, moist surface will drain the battery.
8. Store cabin cushions and other cushions indoors when possible to prevent mildew.
9. Pull all of your electronics and store them inside. Your compass, if built in, should be covered for the winter, as ultraviolet rays from the sun will "cloud" the compass and make it difficult to read.
10. Drain portable heads when they are stored in the boat. Remember to drain both the upper and lower tanks. Heads with deck pumpouts should have all water removed from the lines.
11. Check cleats, chocks, and rails for corrosion and tightness. Use a good quality metal preservative like T-9\*\* on all metal surfaces to prevent saltwater damage.
12. Check for loose silicone, hinges, and unseated gaskets, and replace or tighten where necessary. Heavy seas pounding and twisting the hull can cause leaks in your windows, doors, and hatches. Check all hinges for corrosion and lubricate them.
13. Make sure that the keel, chines, and transom are fully supported.

\*\*The T-9 metal protection product was developed by Boeing Aviation for long-term protection of aircraft. It works by penetrating deeply into fasteners and fixtures, displacing moisture and drying to a clear wax film that lubricates and protects metals for months. T-9 can be used to protect deck hardware, engines, electronics, and fishing tackle.

# HEAD OPERATING INSTRUCTIONS

## PORTABLE HEAD WITH IN-LINE MACERATOR

### OPERATION

1. Depress the bellows pump, located on the left corner of the toilet, to add water to the bowl.
2. Flush the toilet by pulling the slide valve handle out (located on the front of the toilet).
3. Depress the bellows pump until the bowl is rinsed.
4. Close the slide valve handle by pushing it in fully.

### EMPTYING HOLDING TANK BY USE OF OVERBOARD DISCHARGE

1. Place the Y-valve handle in the down position for overboard discharge.
2. Place the seacock handle in the up position to open for overboard discharge (located in the starboard V-berth storage compartment on the 208 Adventure; the port V-berth storage compartment on the 22 Tournament, 22 Seafarer, and 24 Explorer; and under the access plate beneath the cabin step on the 23 Gulfstream and the 25 Dolphin).
3. Depress the helm pump switch (labeled "HEAD PUMP") until the reservoir is empty. (Depending on the proximity of the pump to the reservoir, it may take up to 30 seconds after the switch is depressed before the pump operation begins.) To determine if the reservoir is empty, visually inspect by pulling out the slide valve handle located on the front of the toilet or listen for change in pump sound.
4. Close the seacock by placing the handle in the down position.

### EMPTYING HOLDING TANK THROUGH DECK PUMP-OUT

1. Place the Y-valve handle in the up position for deck pump-out.
2. Remove the cap from deck pump-out, located on the port deck walkaround (forward walkaround on the 208 Adventure).
3. Connect the vacuum hose and run until the tank is empty. Replace the cap on deck pump-out.

\*\*\*\*\*  
**IMPORTANT**  
 \*\*\*\*\*  
 Overboard discharge seacock must be sealed and secured  
 in the closed position within the three mile limit.  
 \*\*\*\*\*



## ACCESSORY WIRING COLOR CODE AND FUSE SIZES

ACCESSORY	WIRE SIZE AND COLOR	AMPERAGE	LOCATION
<b>LIGHTS</b>			
BOW LIGHT	16 GA. GRAY	15.0	ACCESSORY PANEL
AFT POLE LIGHT	16 GA GRAY/WHITE	15.0	ACCESSORY PANEL
MAST LIGHT (FORWARD BULB)	16 GA GRAY RED	15.0	ACCESSORY PANEL
MAST LIGHT (AFT BULB)	16 GA GRAY/BLACK	15.0	ACCESSORY PANEL
PANEL LIGHTS	16 GA DARK BLUE	15.0	ACCESSORY PANEL
CABIN LIGHTS	16 GA DARK BLUE/GREEN	10.0	FUSE BLOCK
COCKPIT LIGHTS	16 GA DARK BLUE	10.0	ACCESSORY PANEL
SPREADER LIGHTS	16 GA DARK BLUE/YELLOW	10.0	ACCESSORY PANEL
<b>PUMPS</b>			
BILGE PUMP (FORWARD):			
RULE 1100	16 GA BROWN	5.0	ACCESSORY PANEL
RULE 1500	16 GA BROWN/BLACK	8.0	ACCESSORY PANEL
AUTO FLOAT SWITCH (FORWARD)	16 GA BROWN/RED IN LINE	4.0	NEAR BATTERY
BILGE PUMP (AFT):			
RULE 1100	16 GA BROWN	5.0	ACCESSORY PANEL
RULE 1500	16 GA BROWN	8.0	ACCESSORY PANEL
AUTO FLOAT SWITCH (AFT)	16 GA BROWN/WHITE IN LINE	4.0	NEAR BATTERY
AERATOR PUMP	16 GA ORANGE/BROWN	2.0	ACCESSORY PANEL
SHOWER SUMP PUMP (FLOAT SWITCH)	16 GA BROWN/ORANGE	4.0	FUSE BLOCK
WATER PRESSURE PUMP (SHOWER)	12 GA ORANGE/RED	15.0	ACCESSORY PANEL
WATER PRESSURE PUMP	16 GA ORANGE/BLUE	2.5	FUSE BLOCK
WASHDOWN & LIVEWELL PUMP	12 ORANGE/BROWN	15.0	ACCESSORY PANEL
PRIMER PUMPS (PORT)	16 GA PINK/RED	5.0	ACCESSORY PANEL
(STARBOARD)	16 GA PINK/BLUE	5.0	ACCESSORY PANEL
<b>MISCELLANEOUS</b>			
BILGE BLOWER	16 GA YELLOW	10.0	ACCESSORY PANEL
HORN	12 GA ORANGE/WHITE	15.0	ACCESSORY PANEL
WINDSHIELD WIPER (ACTUATOR):			
PORT	16 GA ORANGE/GREEN	5.0	ACCESSORY PANEL
STARBOARD	16 GA ORANGE/BLACK	5.0	ACCESSORY PANEL
WINDSHIELD WIPER (POSITION)	16 GA ORANGE		
WINDLASS SOLENOIDS	14 GA ORANGE/PURPLE	*	ACCESSORY PANEL
	14 GA ORANGE/YELLOW	*	ACCESSORY PANEL
WINDLASS POWER LEAD	4 GA RED	*	NEAR BATTERY
	4 GA BLACK	*	NEAR BATTERY
ACCESSORY	16 GA ORANGE	10.0	ACCESSORY PANEL
ACCESSORY GROUNDS (IND)	16 GA BLACK	N/A	
ACCESSORY GROUNDS MAINS	10 GA BLACK	N/A	
HYDRAULIC TRIM TABS	16 GA HARNESS (SUPPLIED)	20.0	FUSE BLOCK
MAIN FUEL TANK (SENDER)	16 GA PINK	2.0	ACCESSORY PANEL
AUXILIARY FUEL TANK (SENDER)	16 GA PINK/WHITE	2.0	ACCESSORY PANEL
ACCESSORY PANEL POWER LEAD	10 GA RED CIRCUIT BREAKER	40.0	NEAR BATTERY
IGNITION SWITCH POWER LEAD	10 GA/18 GA RED IN LINE	20.0	IGNITION
VHF (HARDTOP RADIO BOX)	10 GA RED/WHITE IN LINE	20.0	NEAR BATTERY

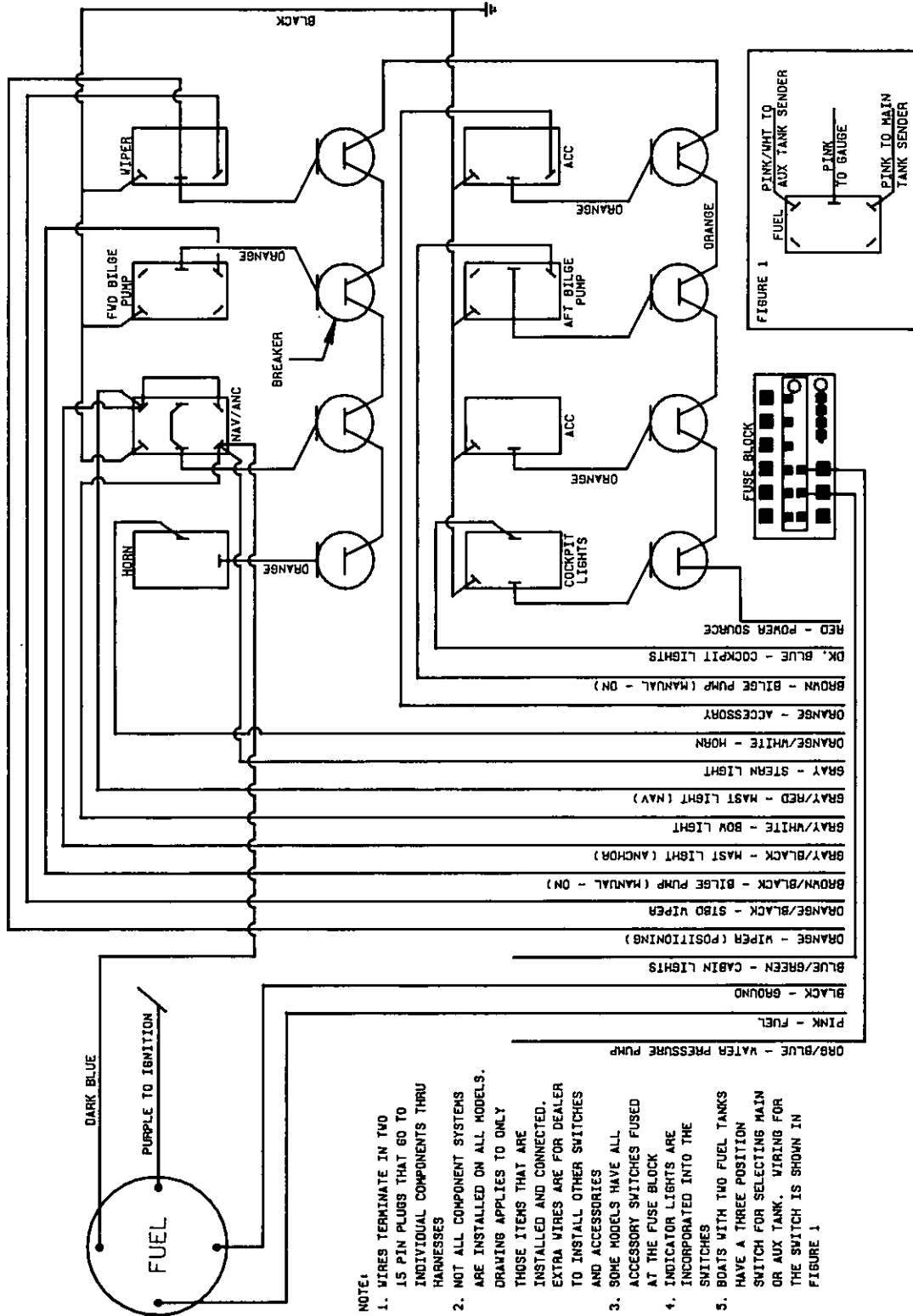

TYPICAL OUTBOARD INSTRUMENT AND SWITCH PANEL WIRING







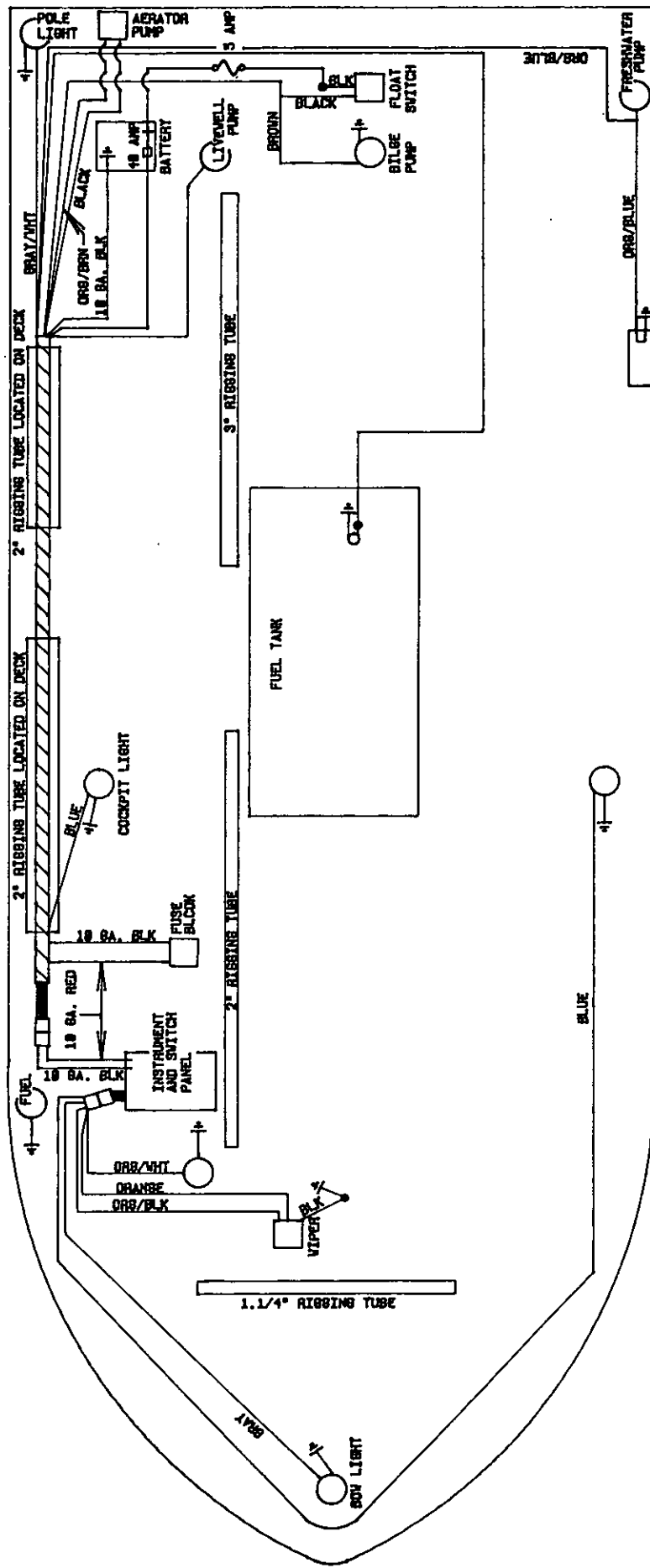

192 TOURNAMENT ACCESSORY WIRING DIAGRAM

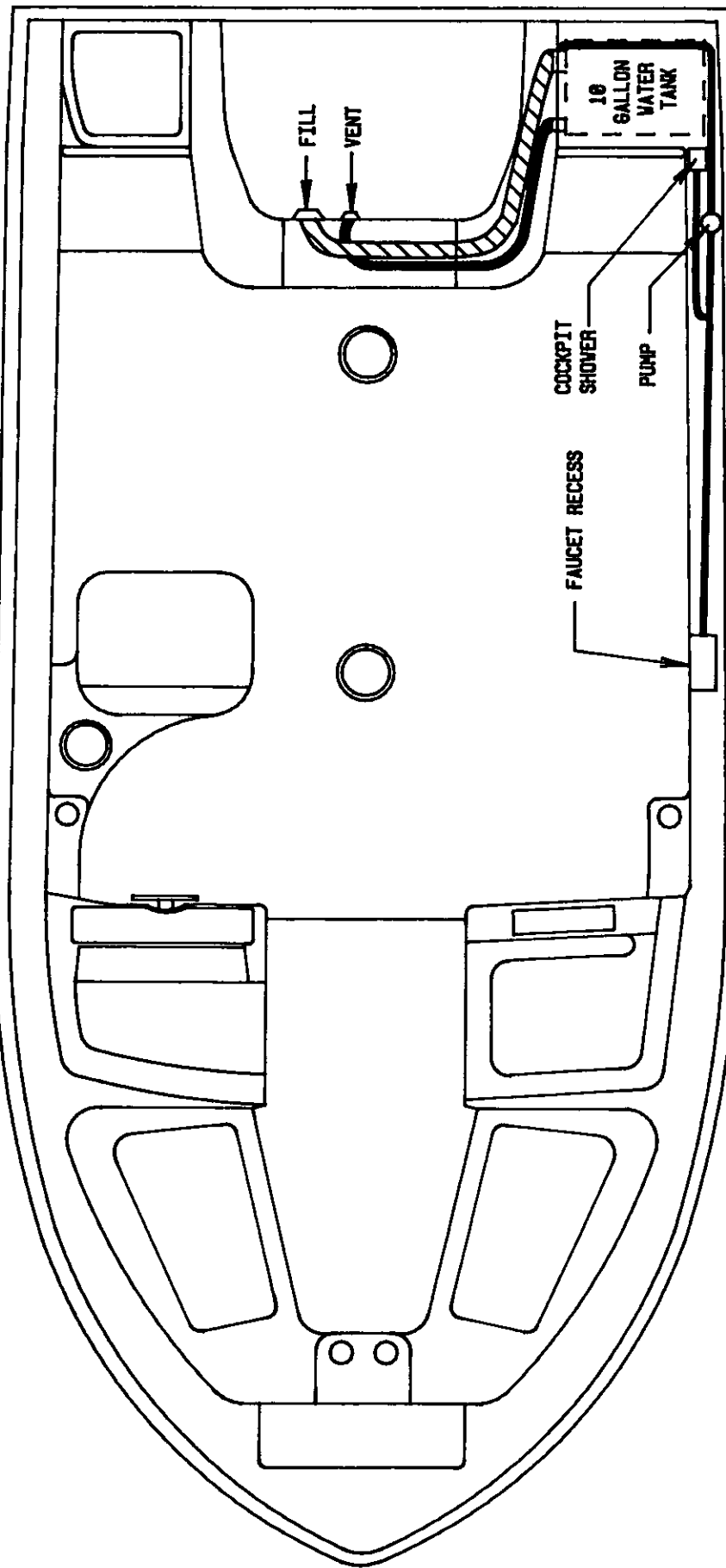

192 TOURNAMENT FRESH WATER SYSTEM

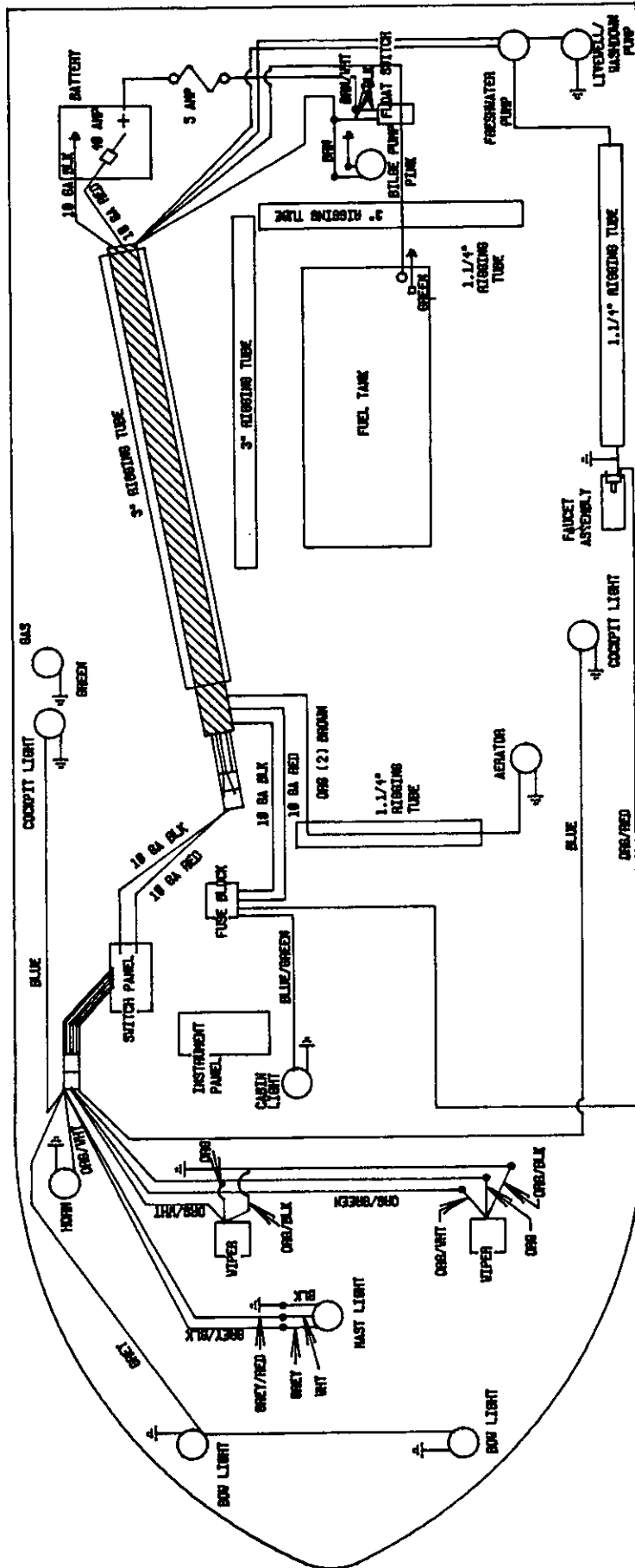

208 ADVENTURE ACCESSORY WIRING DIAGRAM

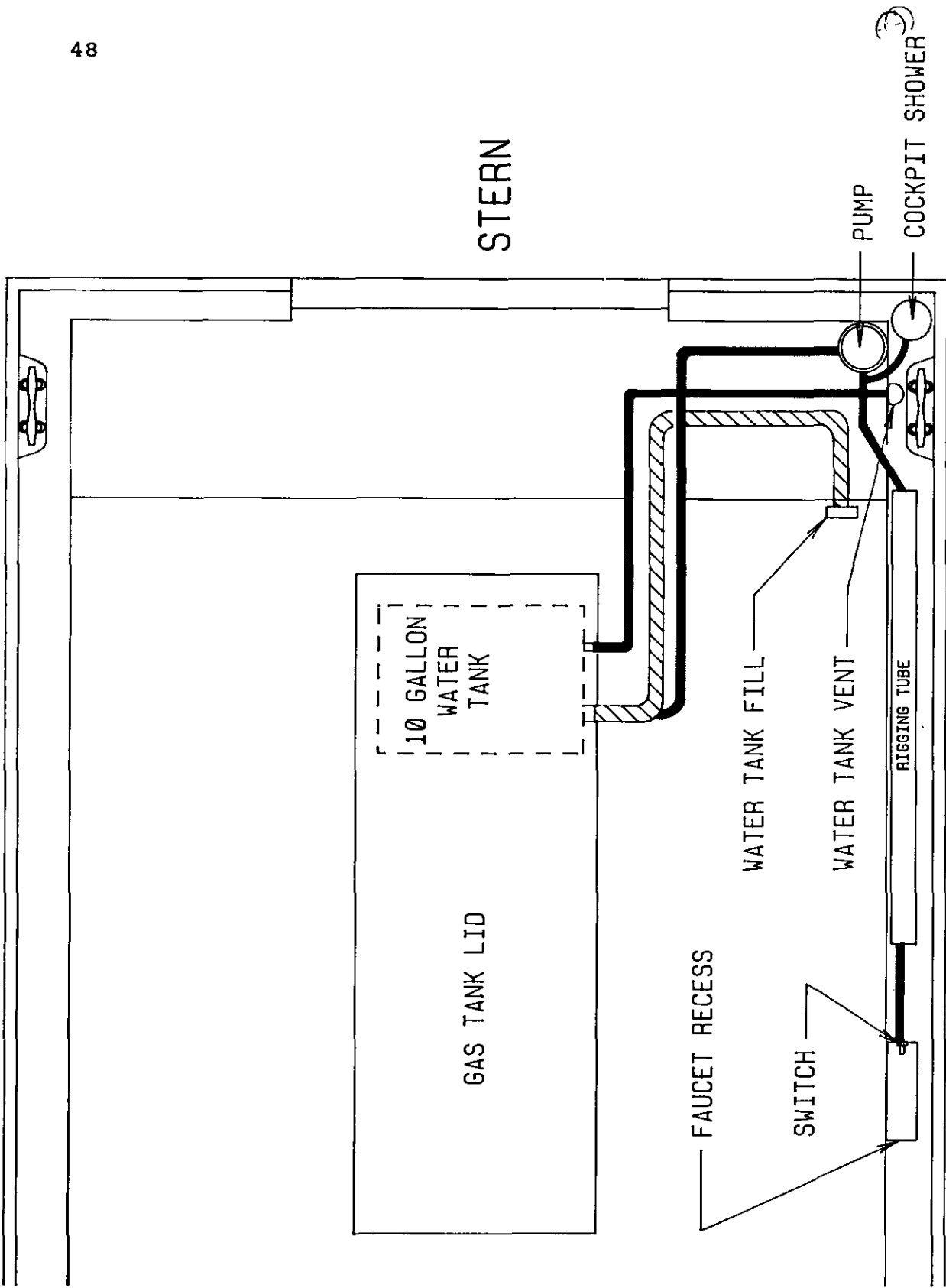

208 ADVENTURE FRESH WATER SYSTEM

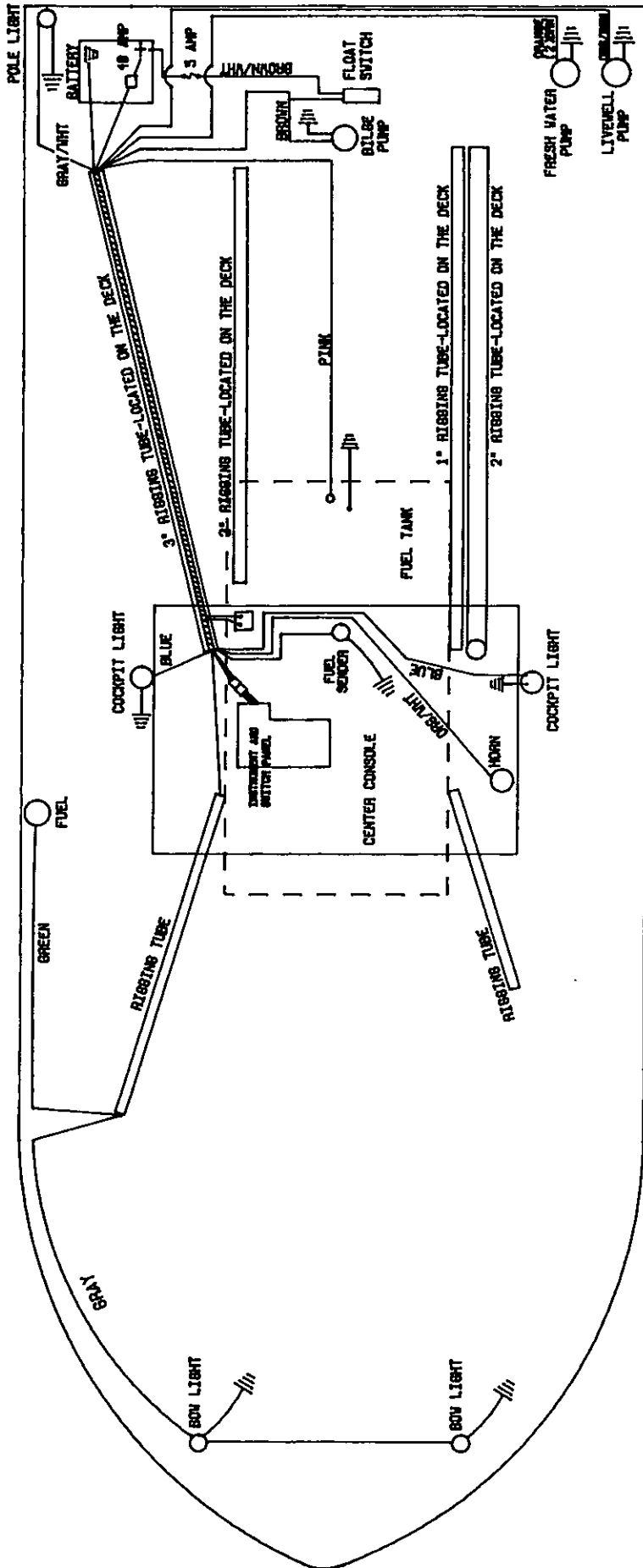

209 ESCAPE ACCESSORY WIRING DIAGRAM

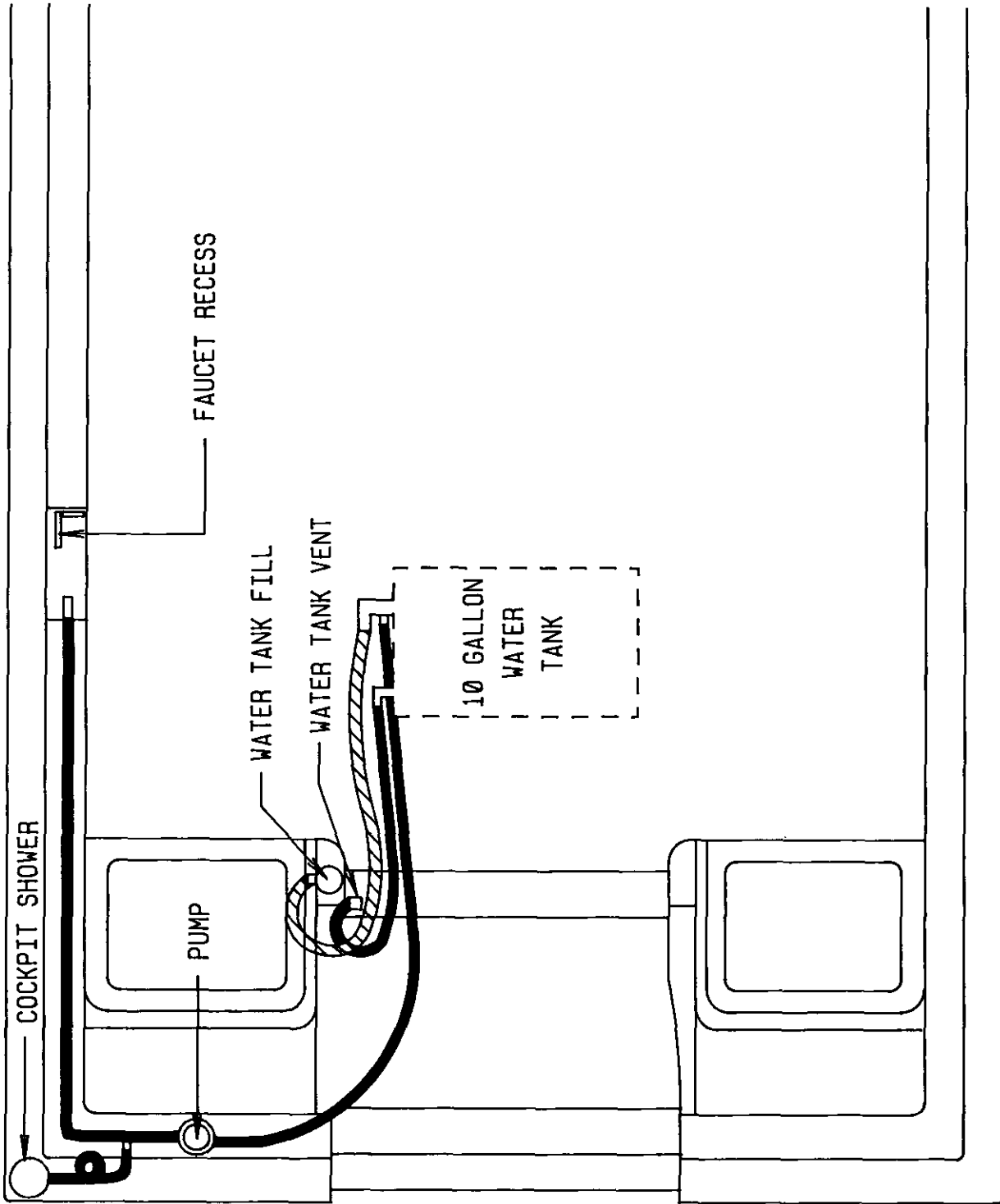

STERN

209 ESCAPE FRESH WATER SYSTEM



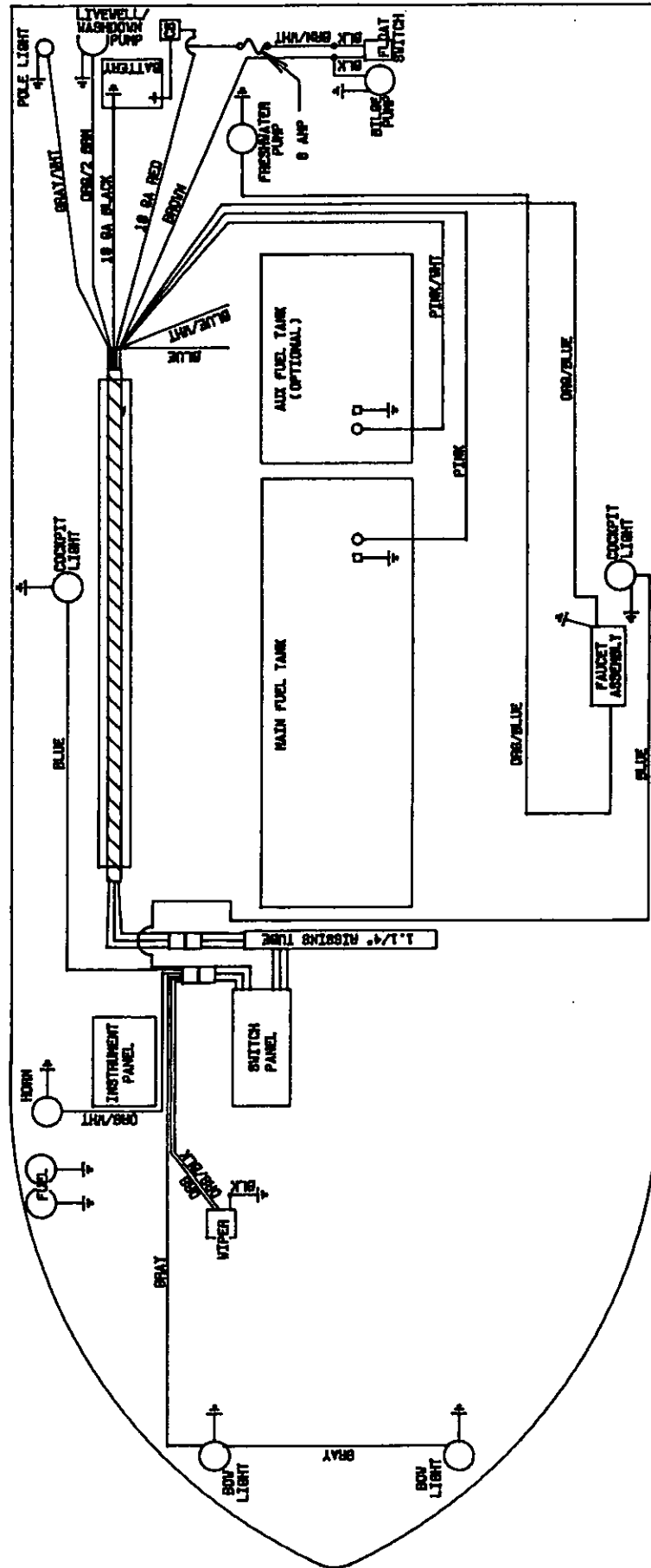

22' TOURNAMENT ACCESSORY WIRING DIAGRAM

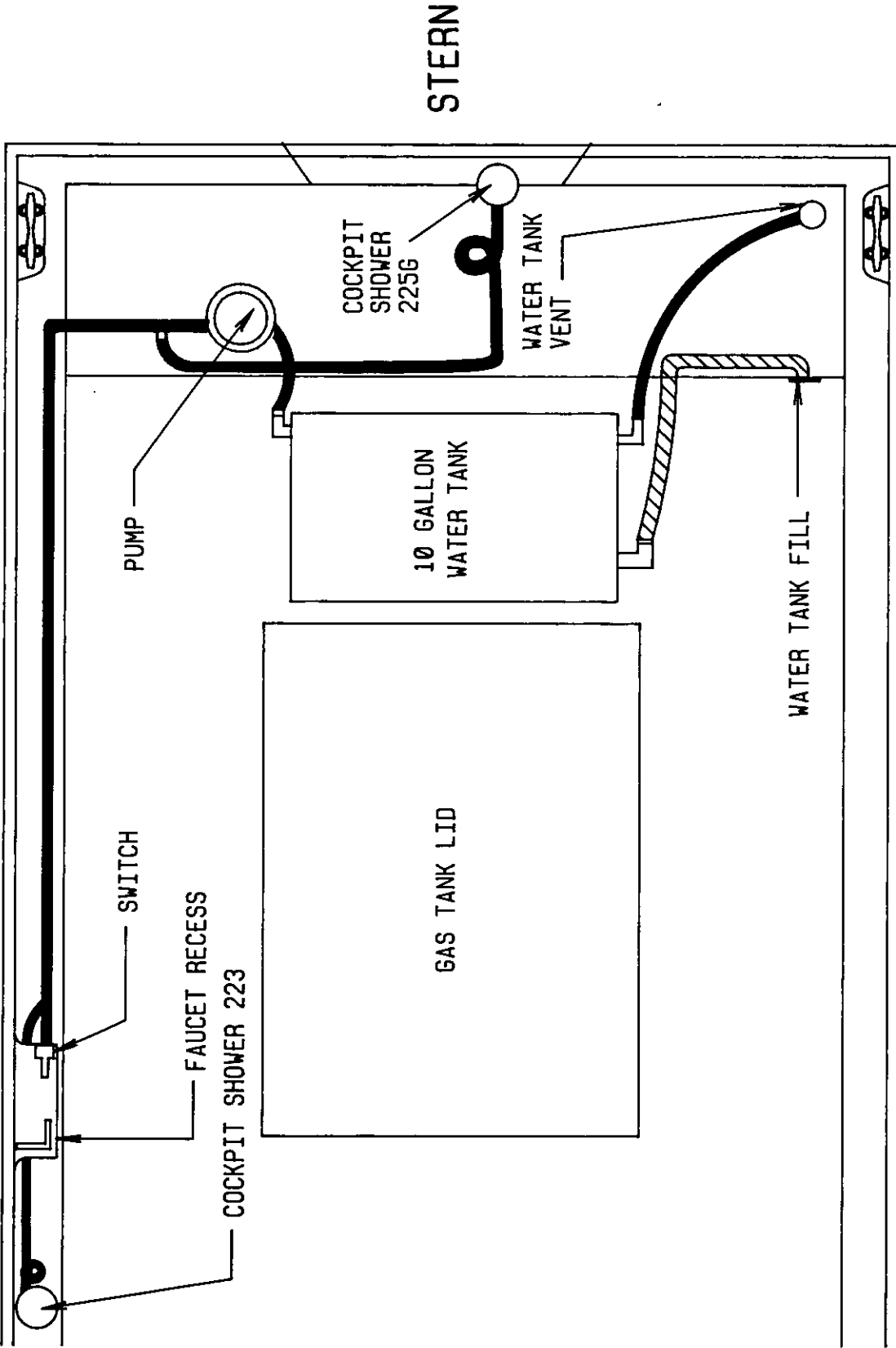

22' TOURNAMENT FRESH WATER SYSTEM

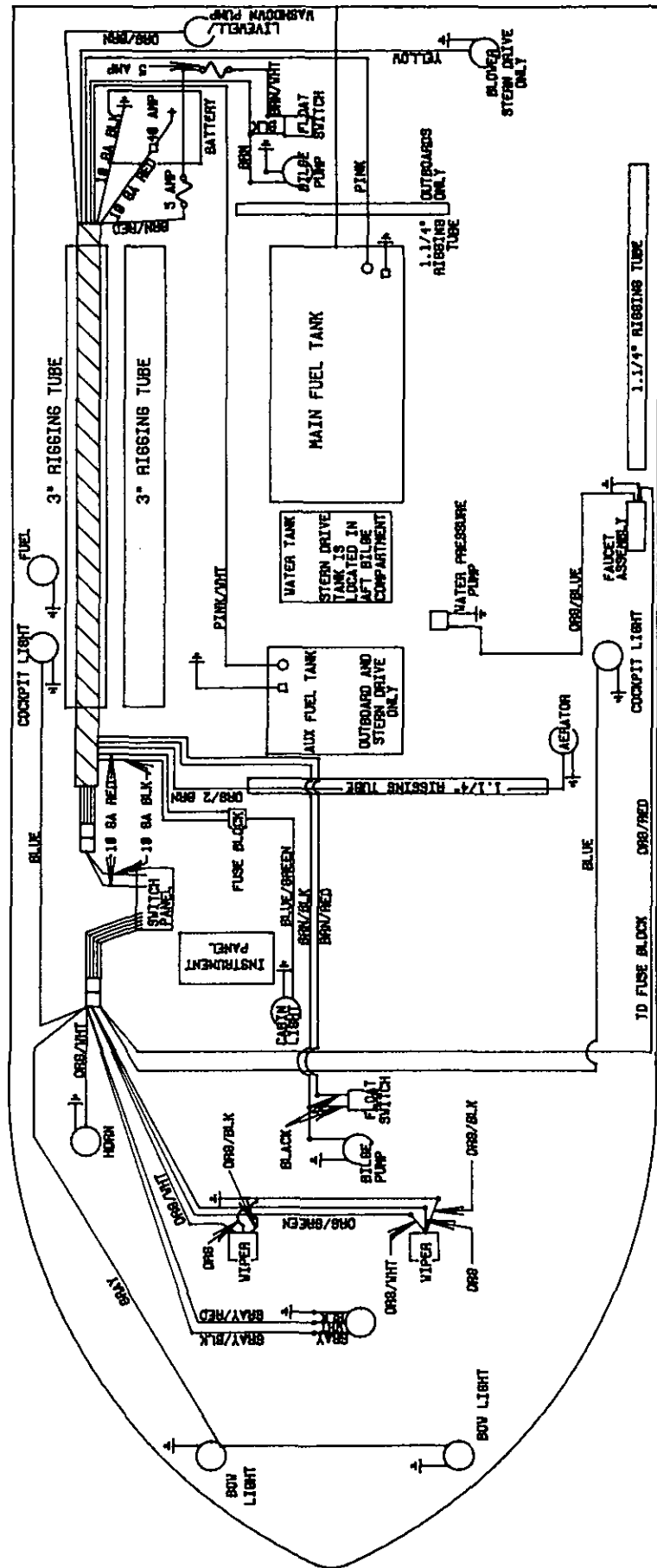

22' SEAFARER ACCESSORY WIRING DIAGRAM

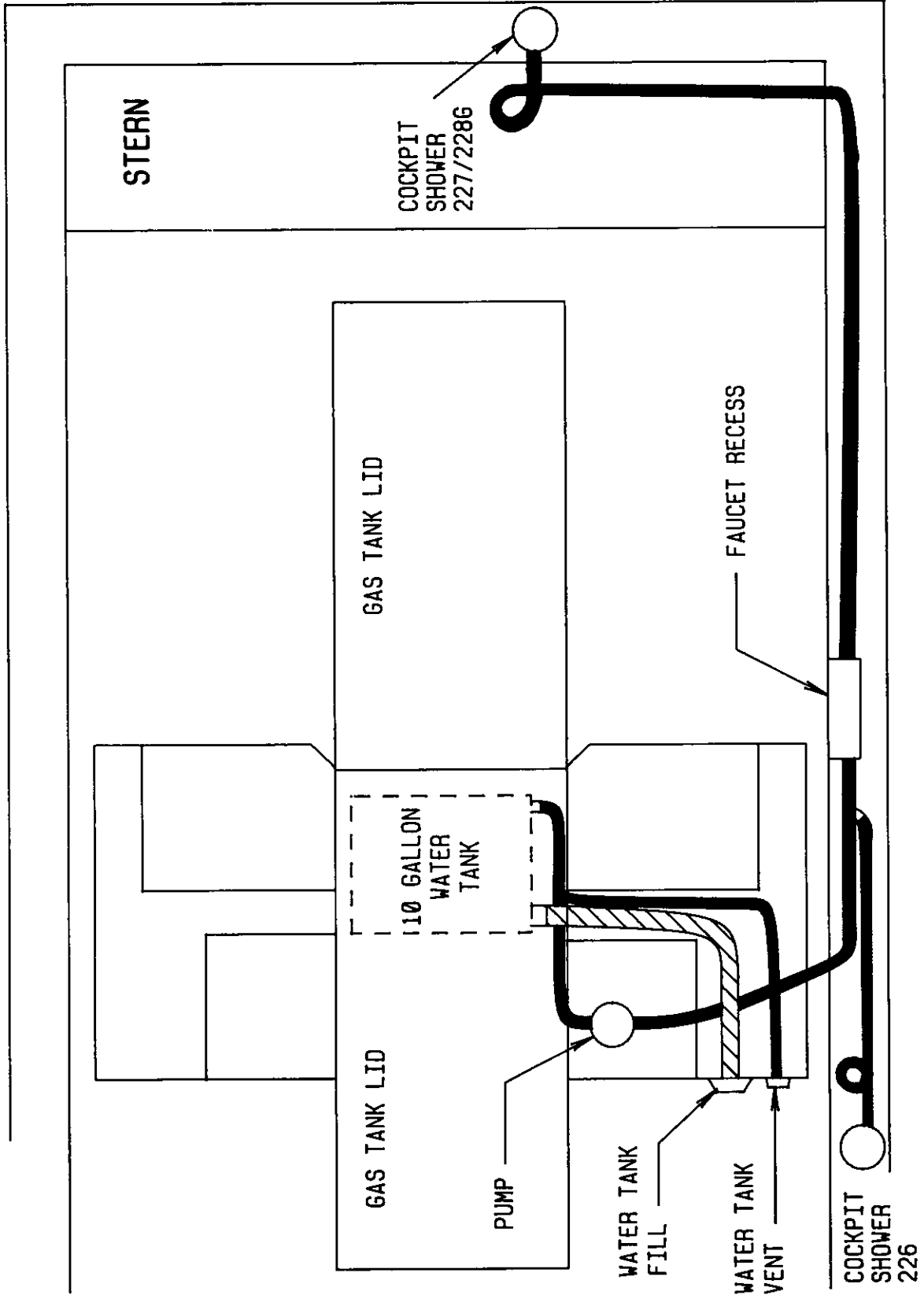

22' SEAFARER FRESH WATER SYSTEM

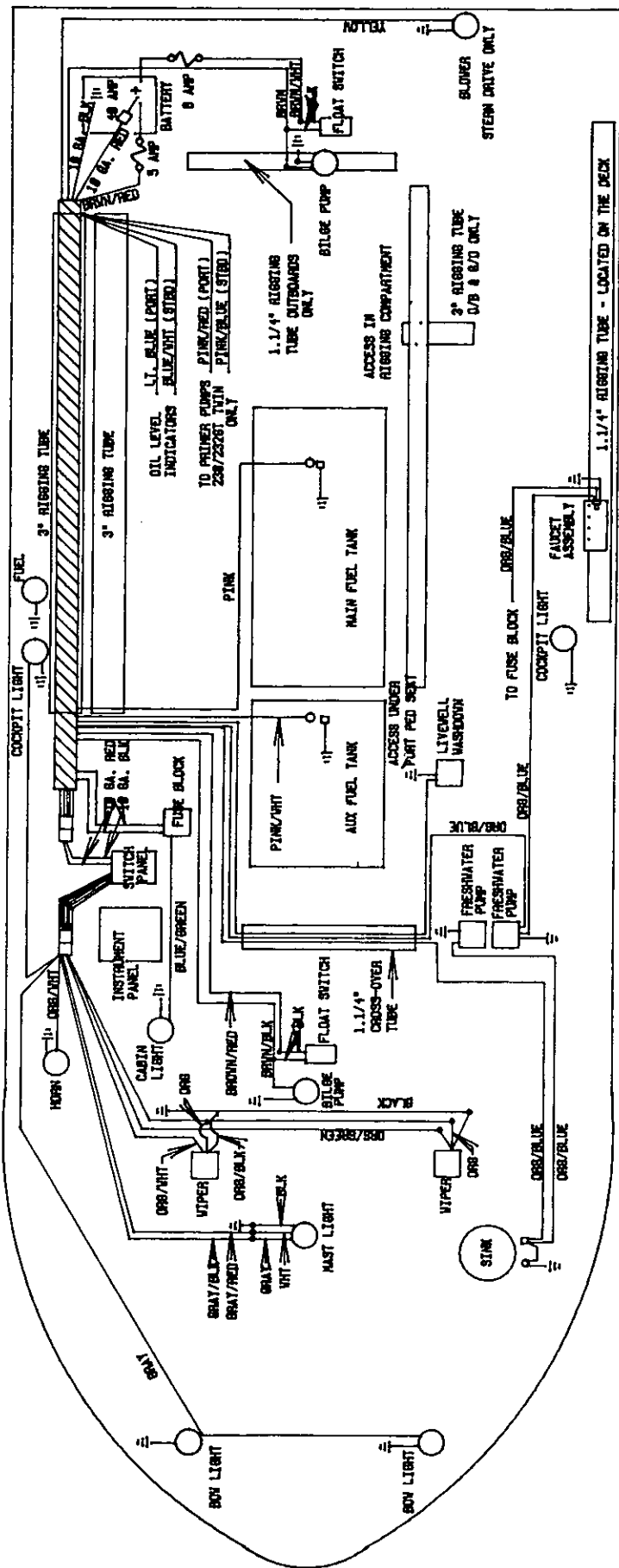

23' GULFSTREAM ACCESSORY WIRING DIAGRAM

**23' GULFSTREAM FRESH WATER SYSTEM**

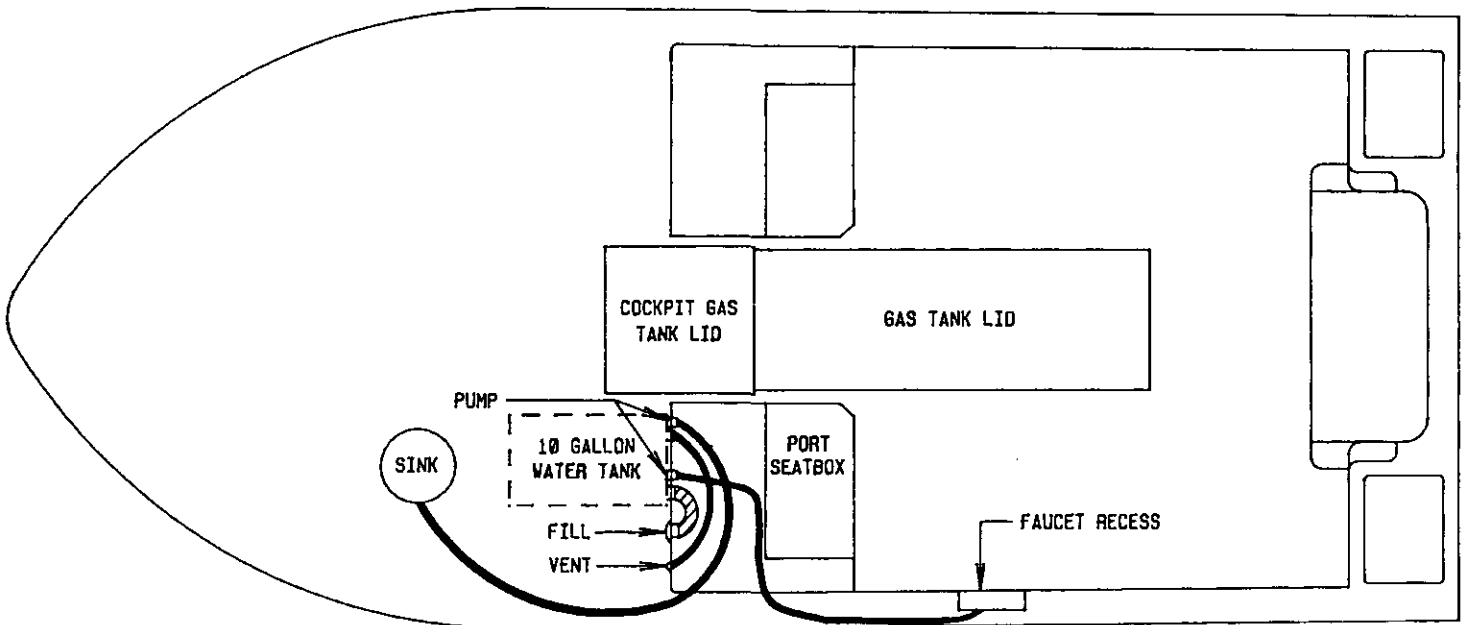

**WITH GUNWALE MOUNT FRESH WATER SYSTEM**

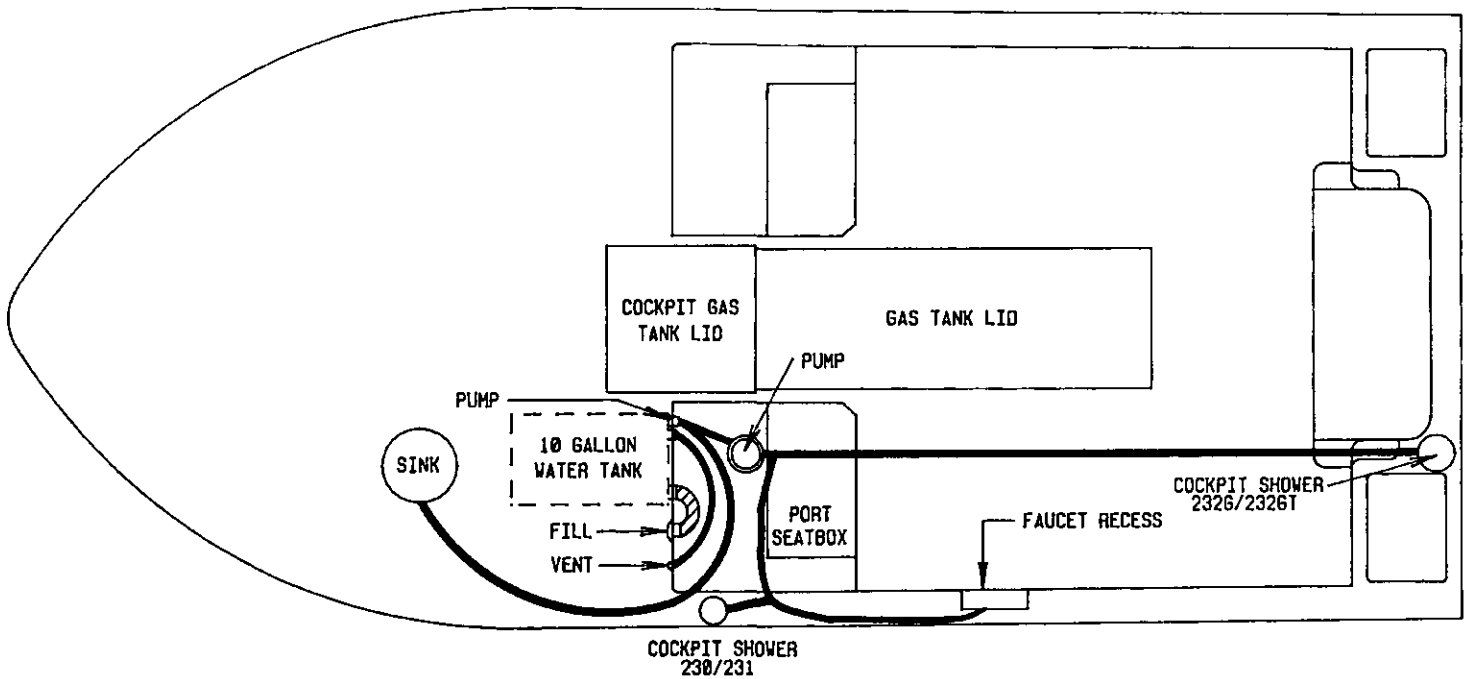

**WITH COCKPIT SHOWER OR COMBINATION COCKPIT SHOWER/  
GUNWALE MOUNT FRESH WATER**

*Moved  
to here*

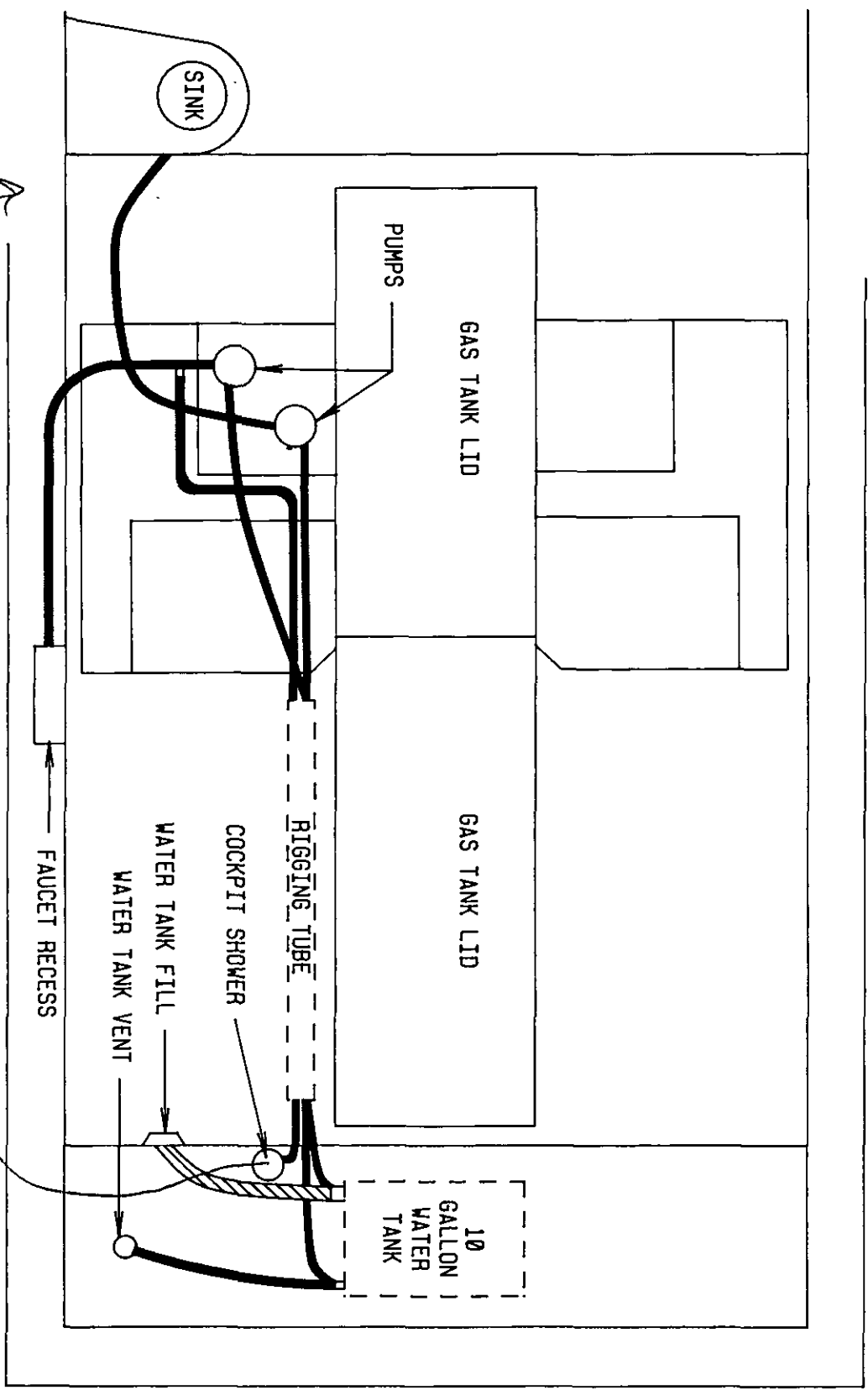

**244 EXPLORER FRESH WATER SYSTEM**

# 24' EXPLORER ACCESSORY WIRING DIAGRAM

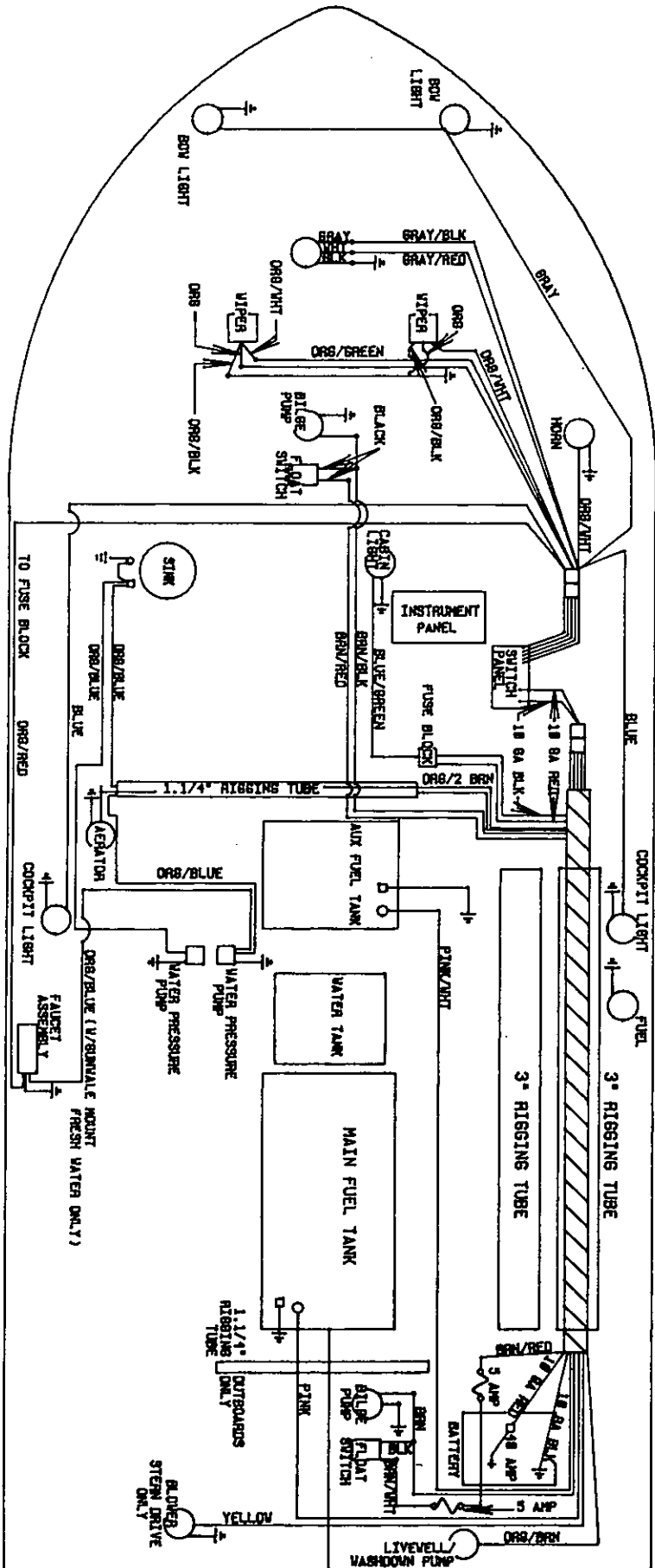



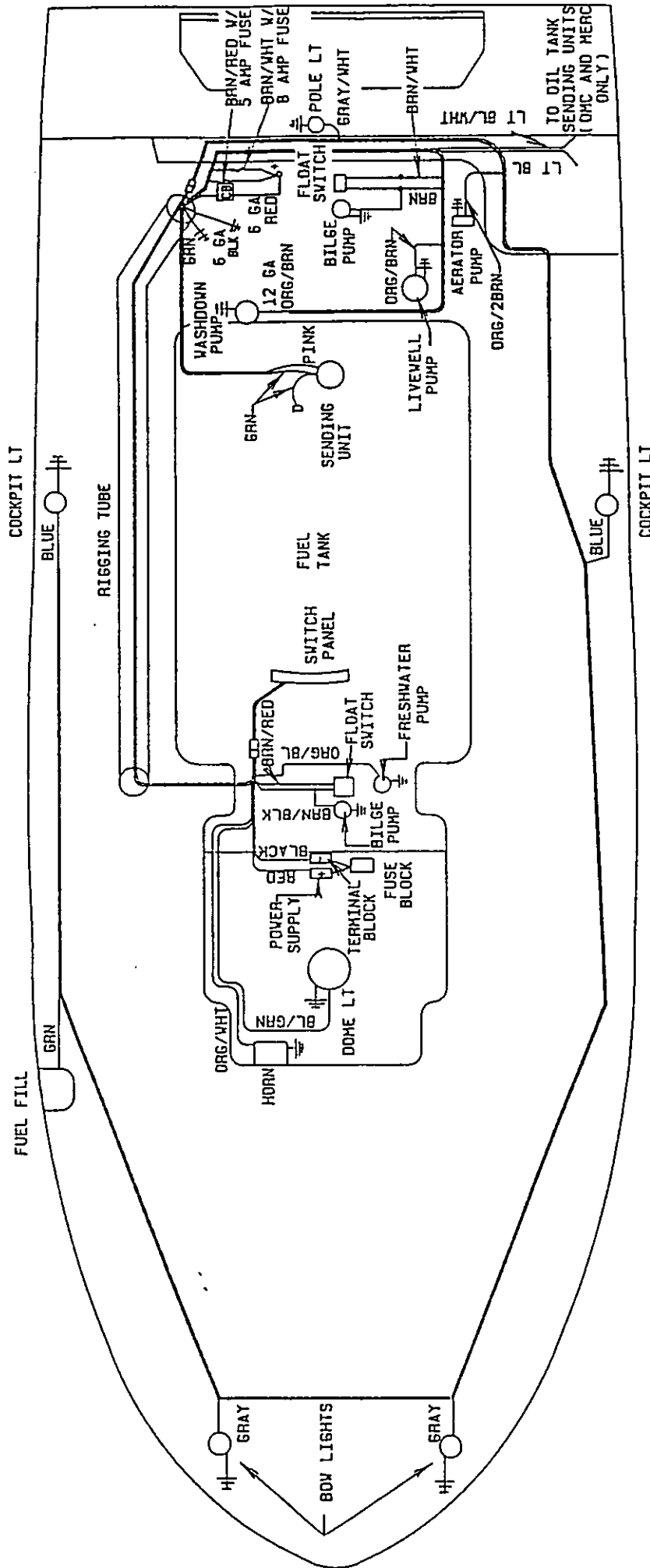

243 CHASE ACCESSORY WIRING DIAGRAM

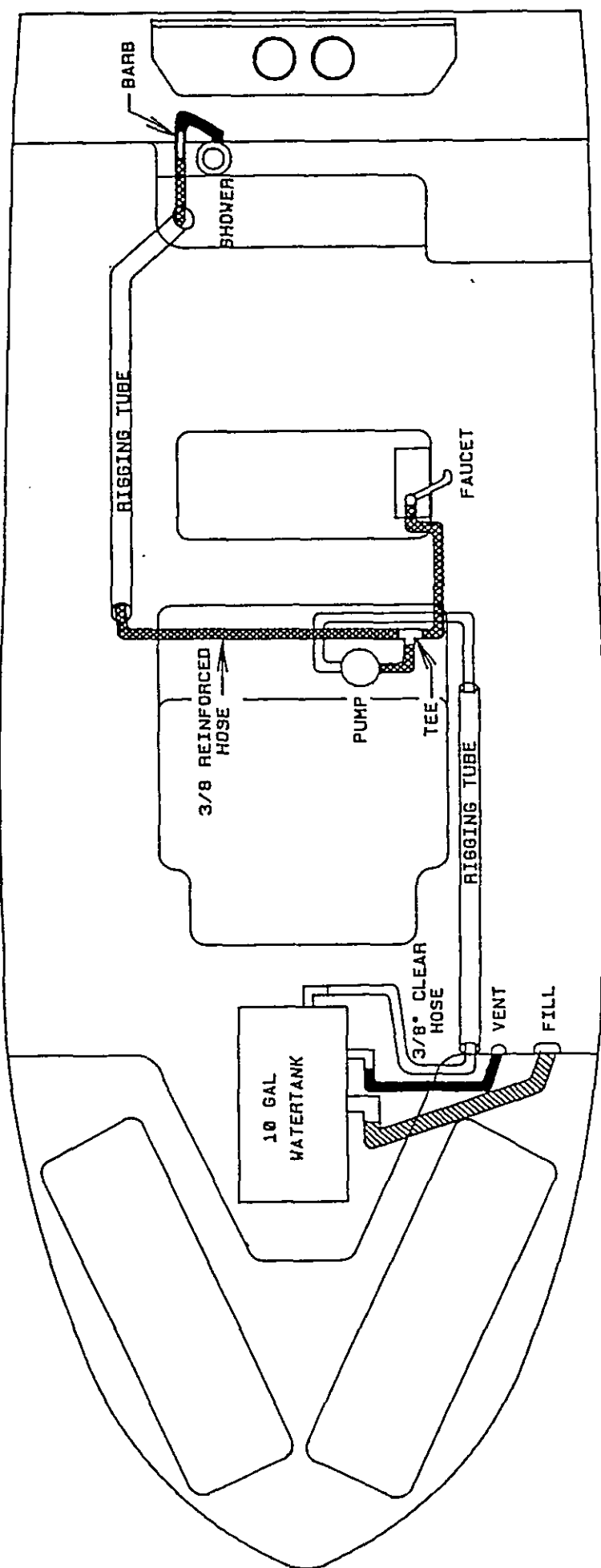

# 243 CHASE FRESH WATER SYSTEM

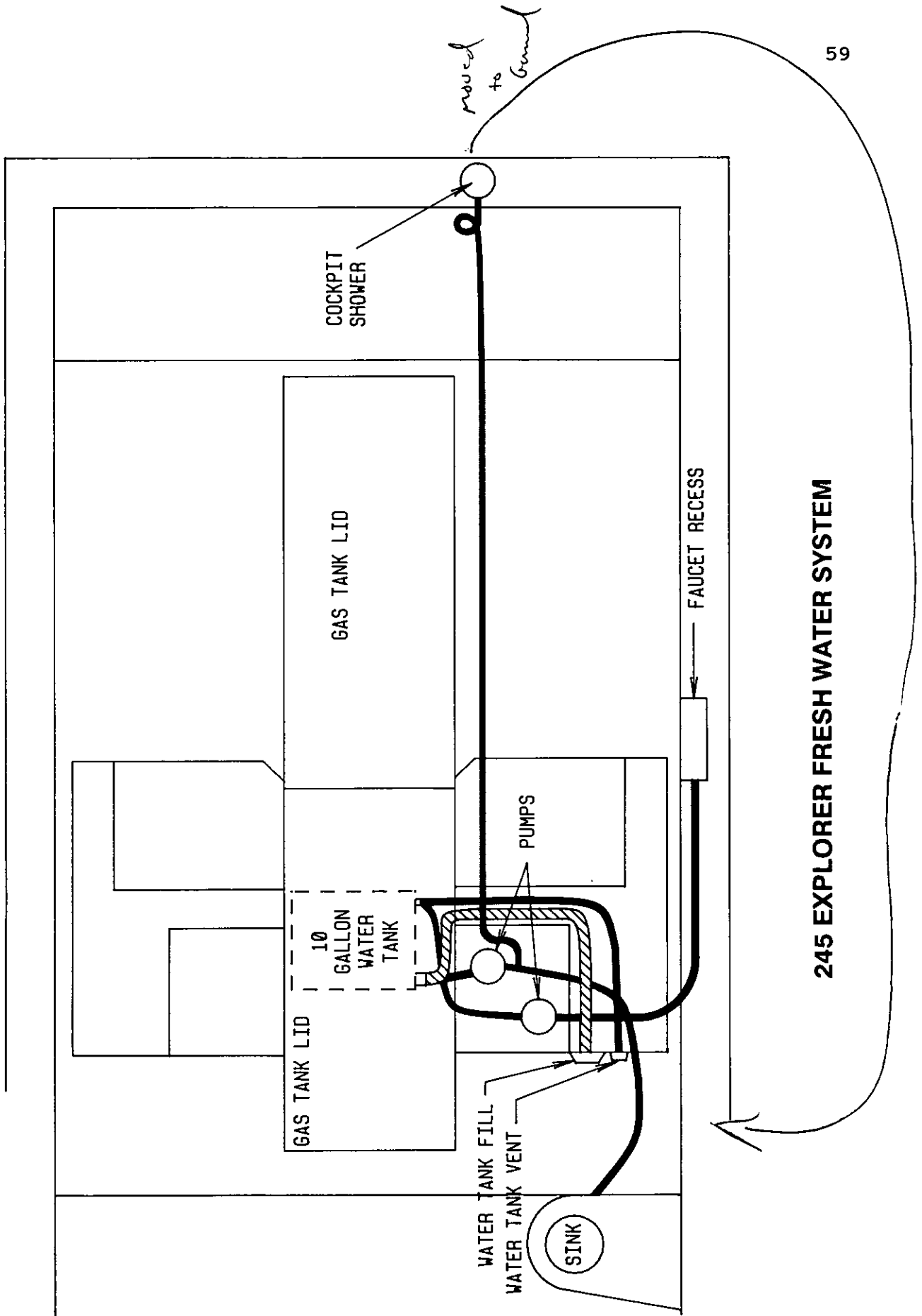

245 EXPLORER FRESH WATER SYSTEM

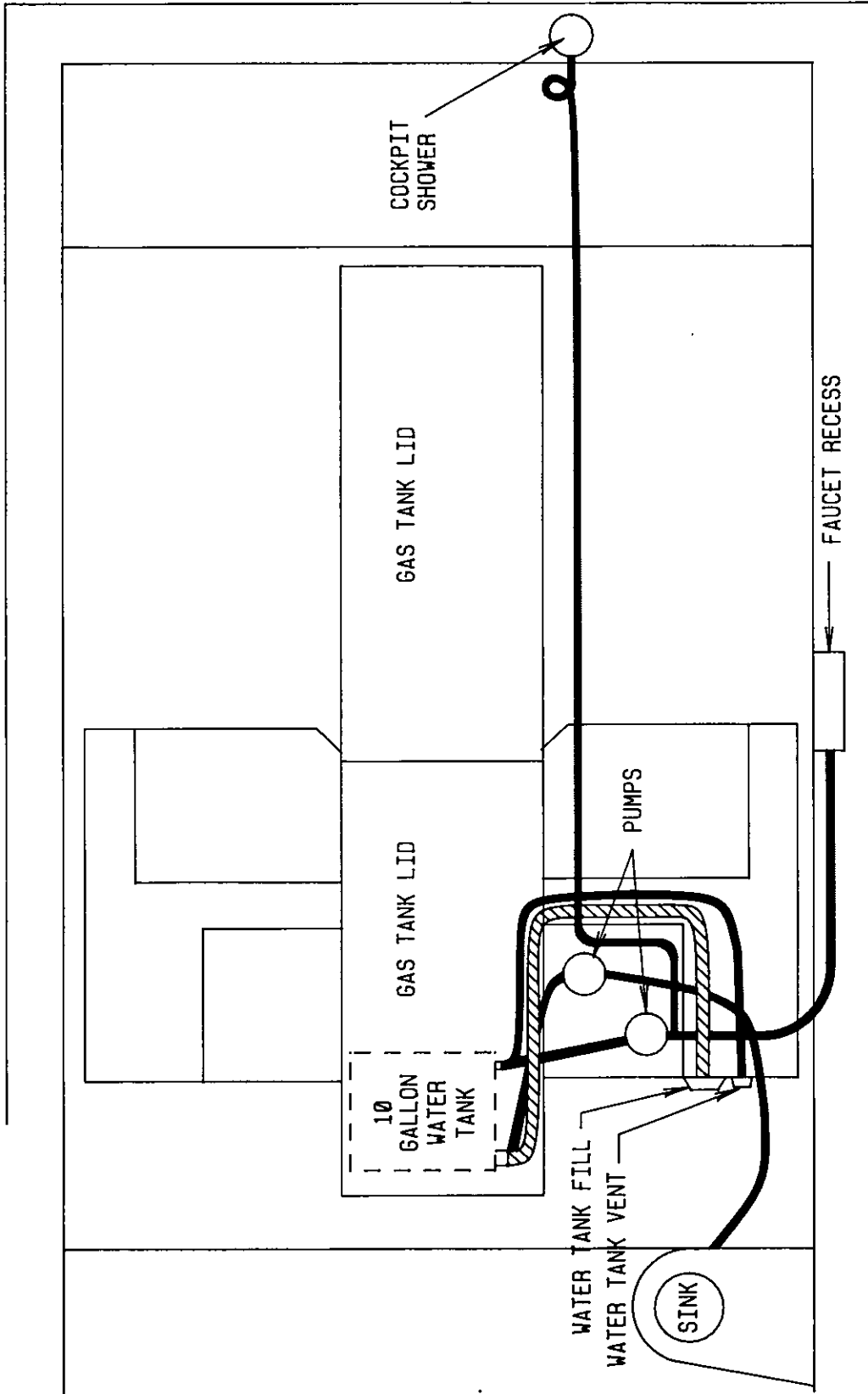

246G EXPLORER FRESH WATER SYSTEM

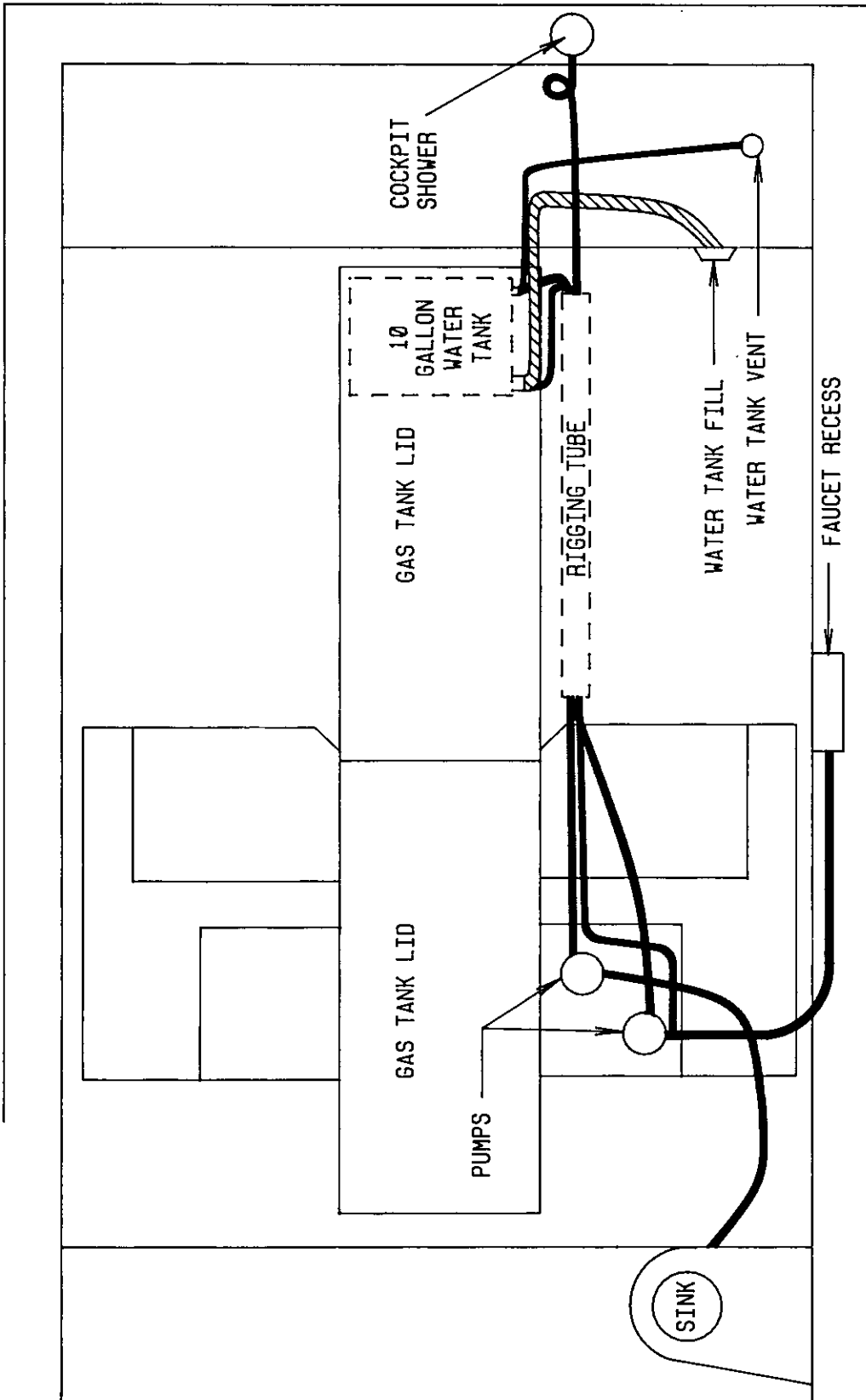

246GT EXPLORER FRESH WATER SYSTEM



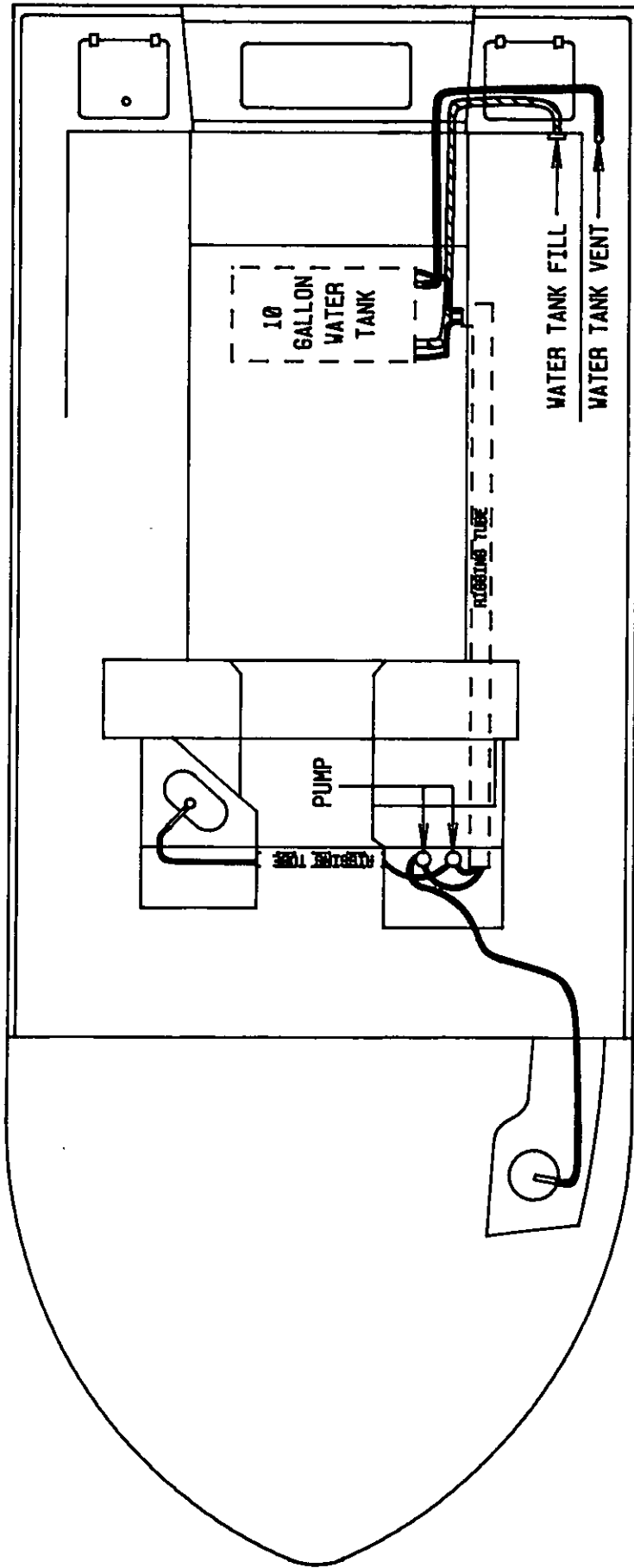

250/253GT DOLPHIN FRESH WATER SYSTEM

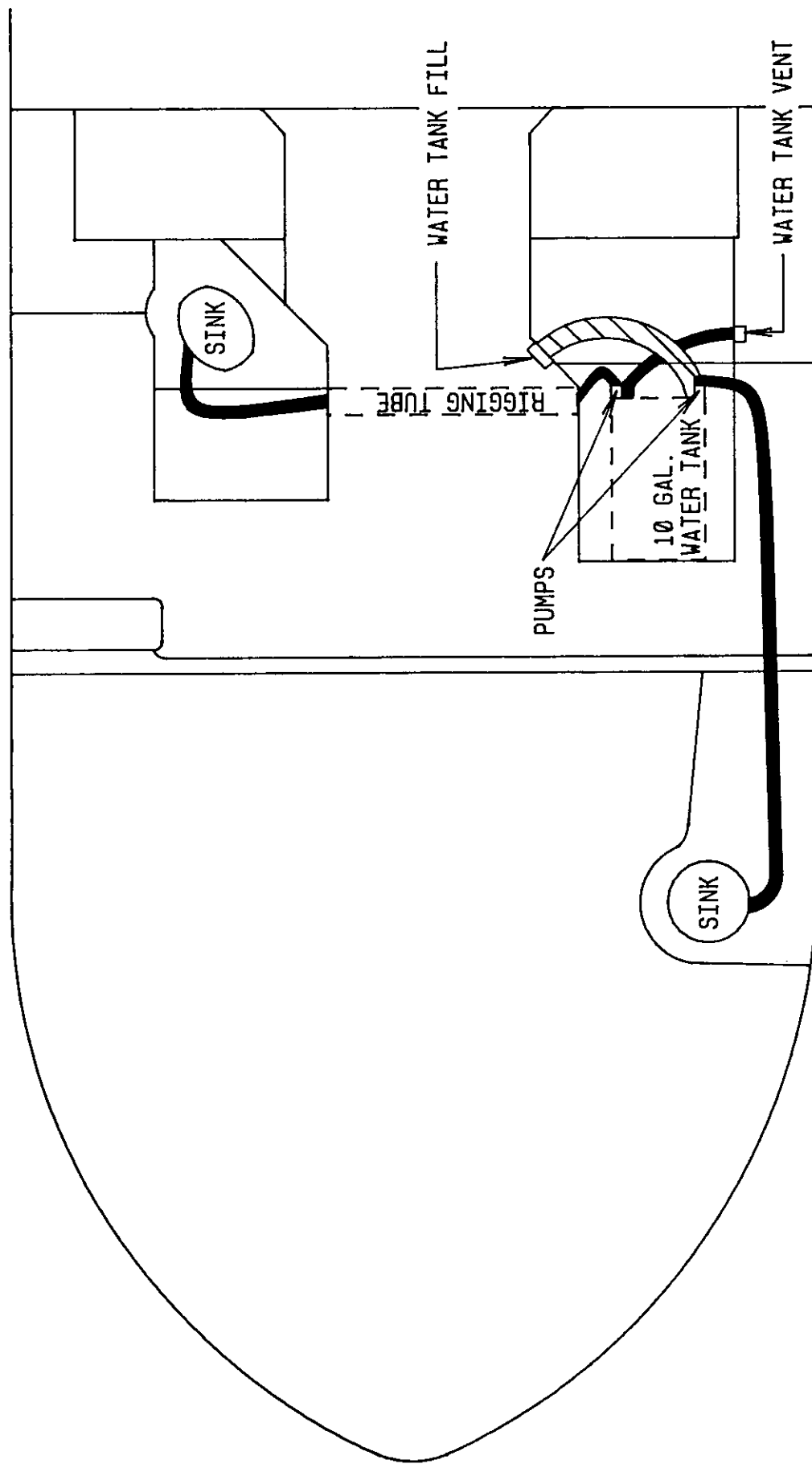

251 DOLPHIN FRESH WATER SYSTEM



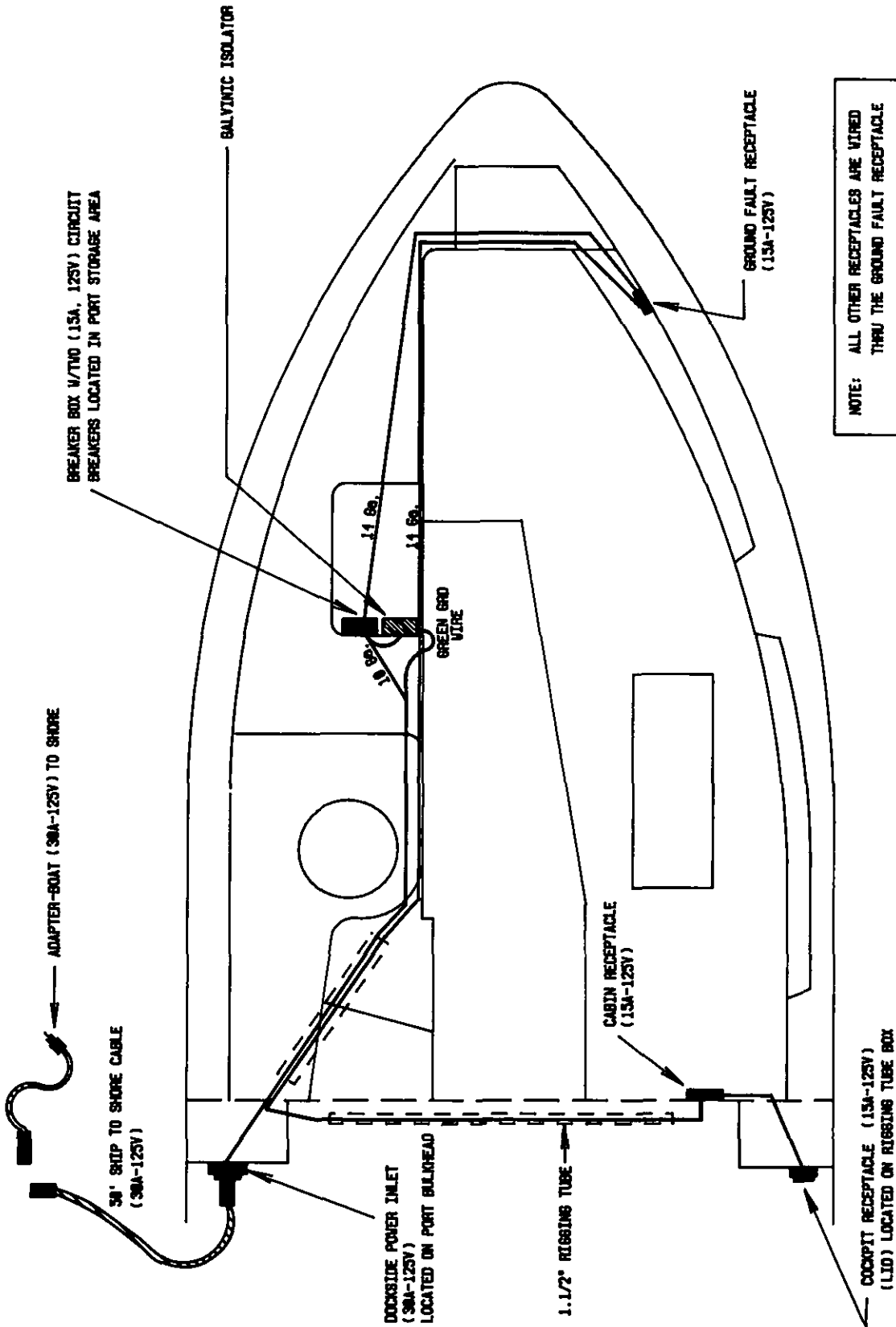

25' DOLPHIN DOCKSIDE POWER WIRING DIAGRAM

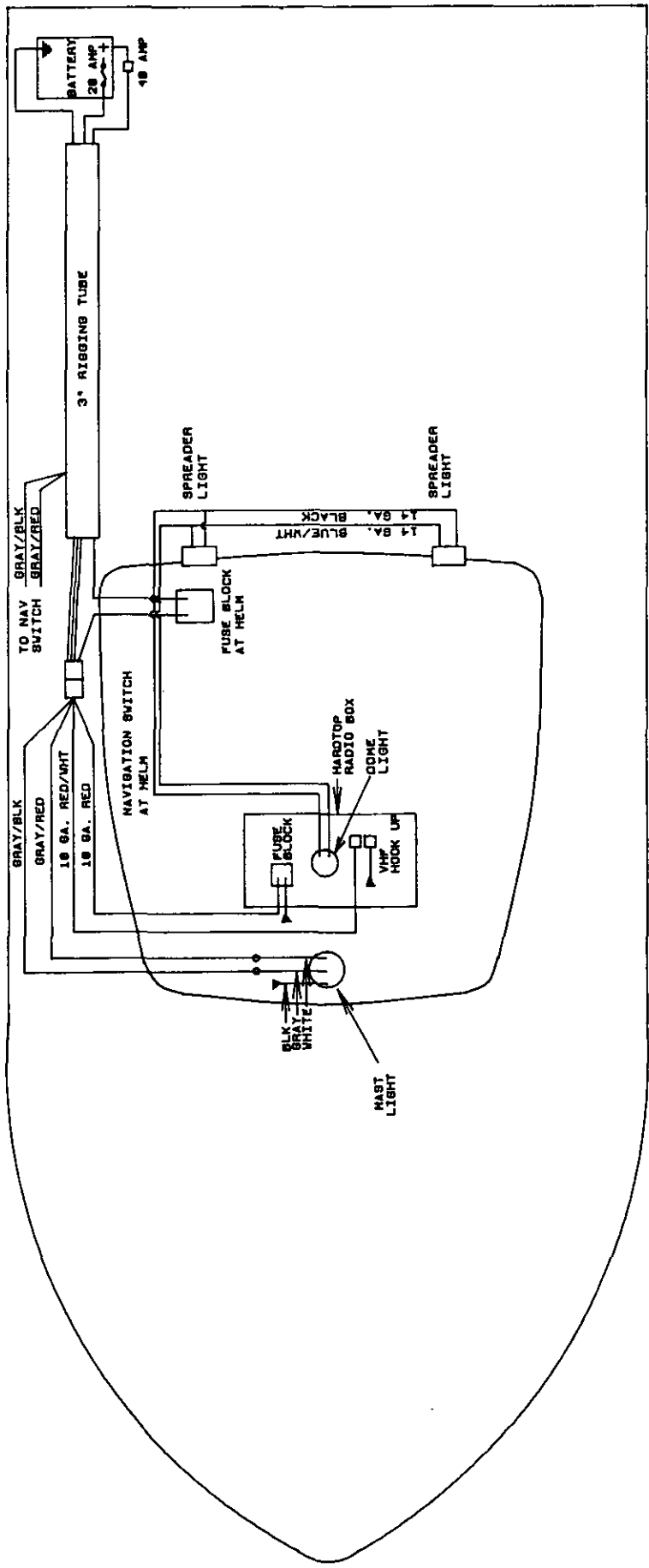

HARDTOP WIRING DIAGRAM: 20' / 22' / 23' / 24' SERIES

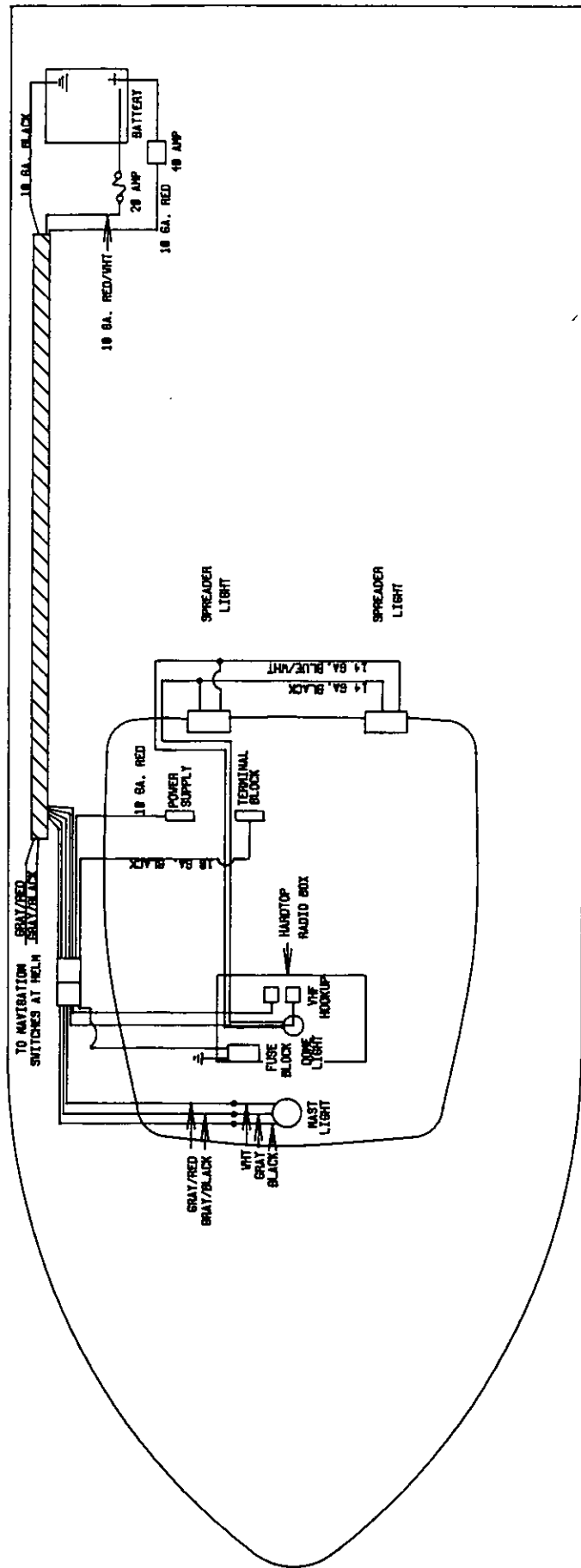

HARDTOP WIRING DIAGRAM: 25' DOLPHIN

## AC WIRING SCHEMATIC AND WARNING LABEL

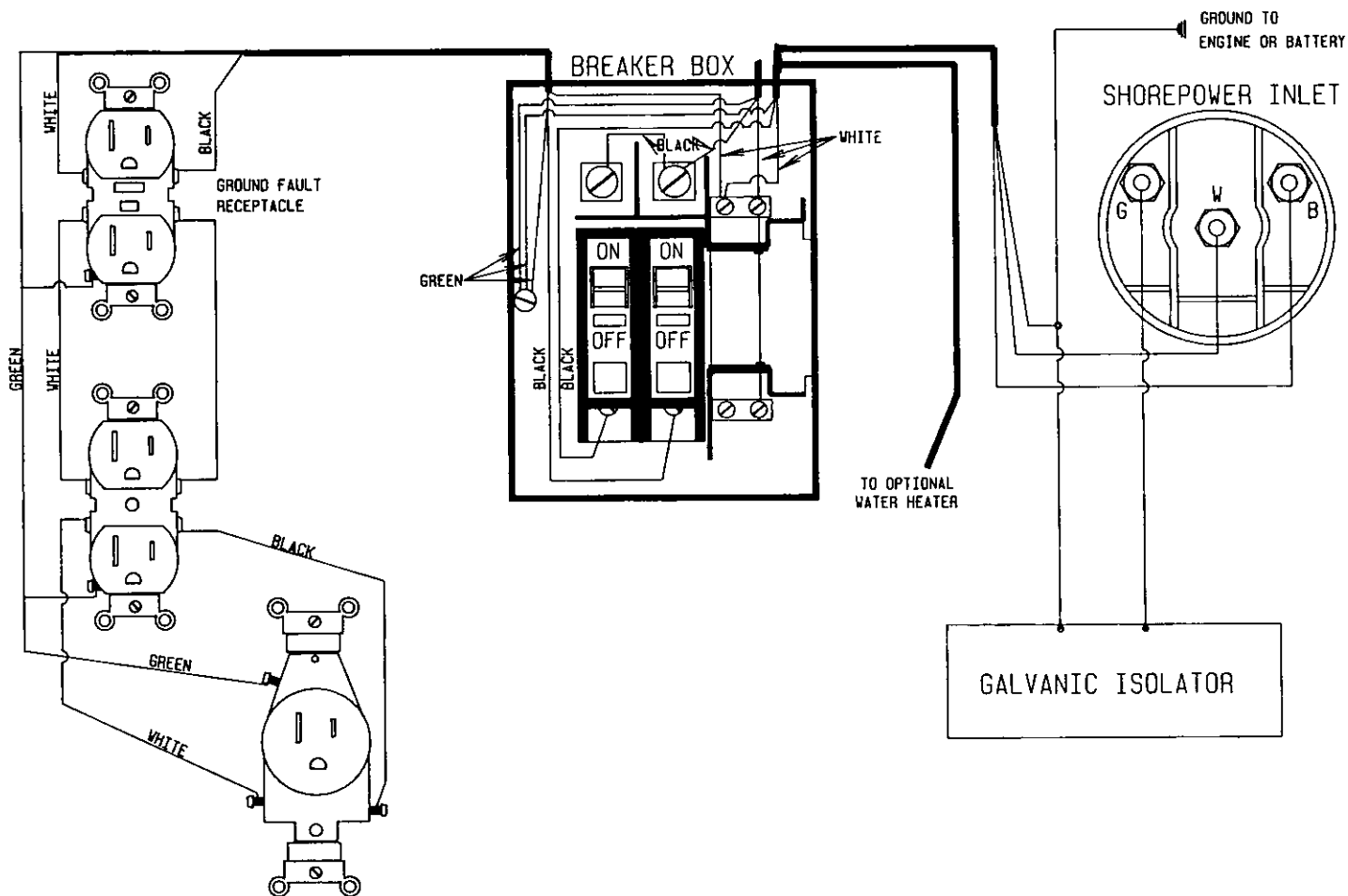

### WARNING

- (1) TURN OFF THE BOAT'S SHORE CONNECTION SWITCH BEFORE CONNECTING OR DISCONNECTING SHORE CABLE
- (2) CONNECT SHORE-POWER CABLE AT THE BOAT FIRST
- (3) DISCONNECT SHORE-POWER CABLE AT SHORE-OUTLET FIRST
- (4) CLOSE SHORE-POWER INLET COVER TIGHTLY
- (5) DO NOT ALTER SHORE-POWER CABLE CONNECTORS

# WASHDOWN/LIVEWELL SYSTEM

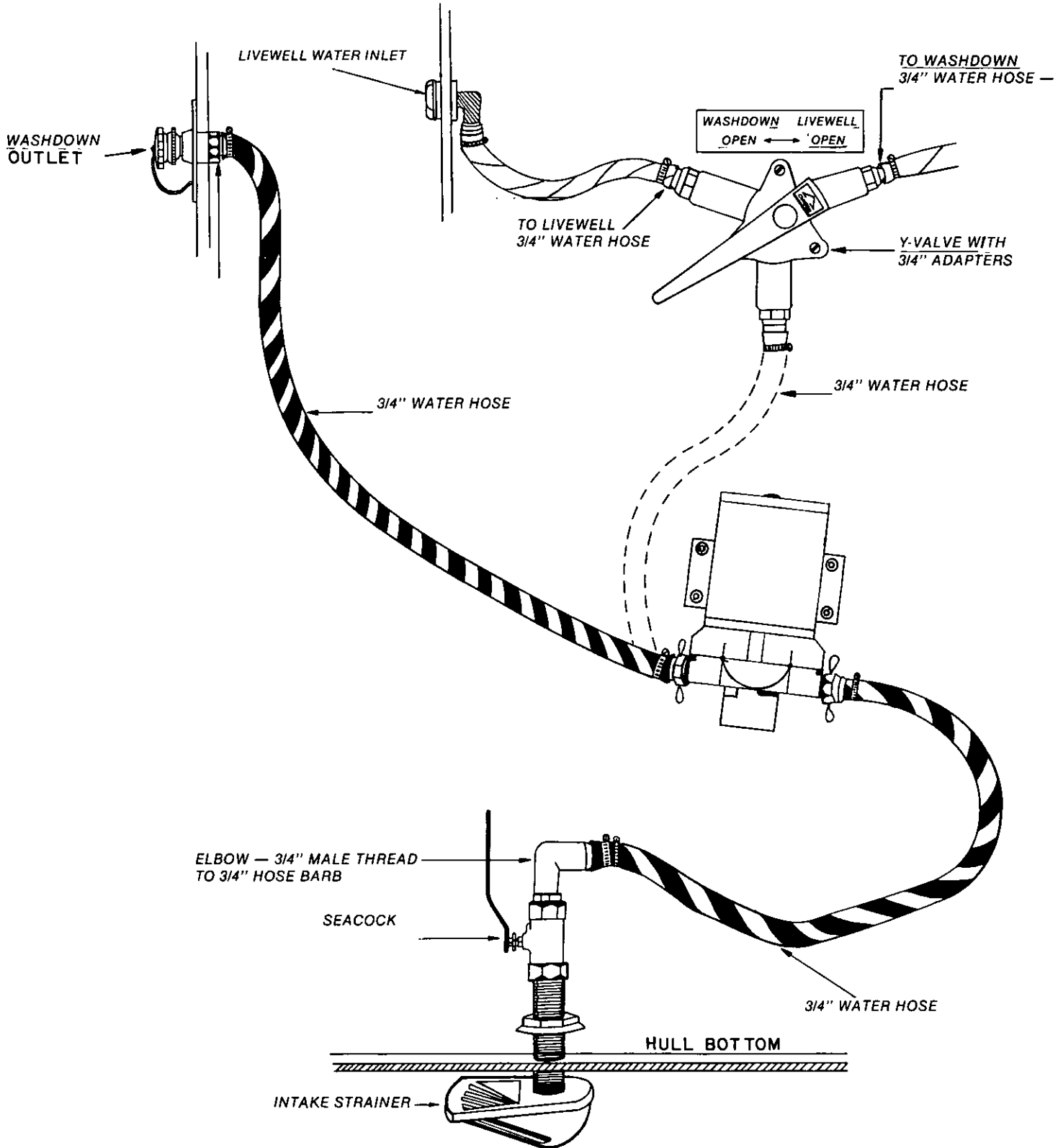

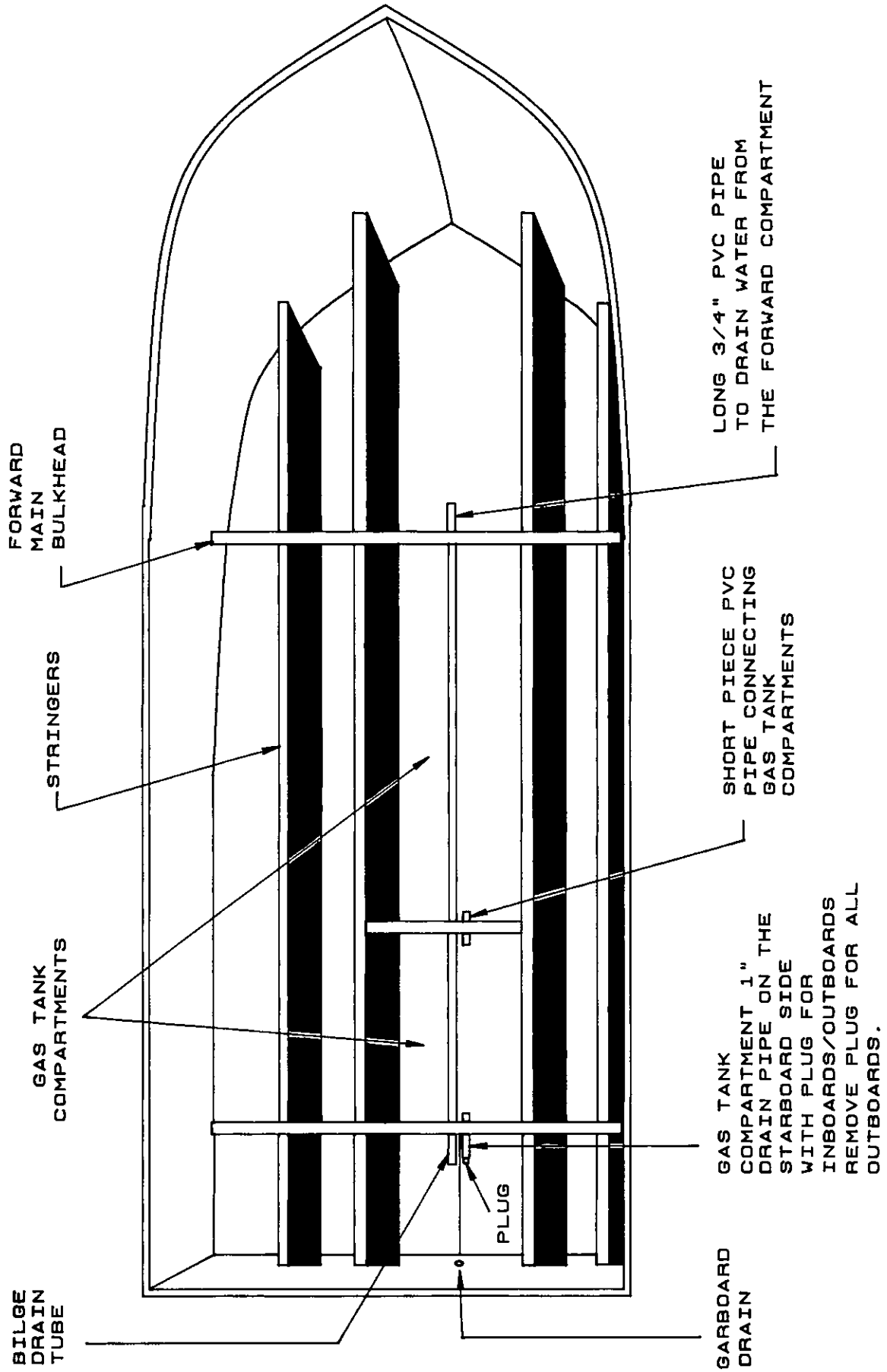

**TYPICAL FUEL TANK DRAINAGE**

**Grady-White Construction**

Most Grady-Whites are built in three separate fiberglass pieces, the hull, the deck and the fiberglass liner as shown below. These three pieces are bonded together after installation of standard through-bolted hardware, electrical systems, gas tanks and foam floatation.

**The deck**

All standard hardware is mounted and secured with through bolts and locking nuts before being installed in the boat. The deck is then placed on the hull/liner and secured all around.

**The fiberglass liner**

The fiberglass liner of your Grady-White is removed from its mold then all fishboxes and ice boxes are insulated with foam. The liner is then placed in the hull, the deck placed over both, and all three are bonded then secured with stainless steel screws all around.

**The hull**

The wooden stringer system in your Grady-White is encapsulated in resin and fiberglass then fiberglassed into place while the hull is still in its mold. This gives your hull permanent strength and shape. Foam floatation is sprayed into strategic cavities between the stringers to add floatation, strength and sound absorption.

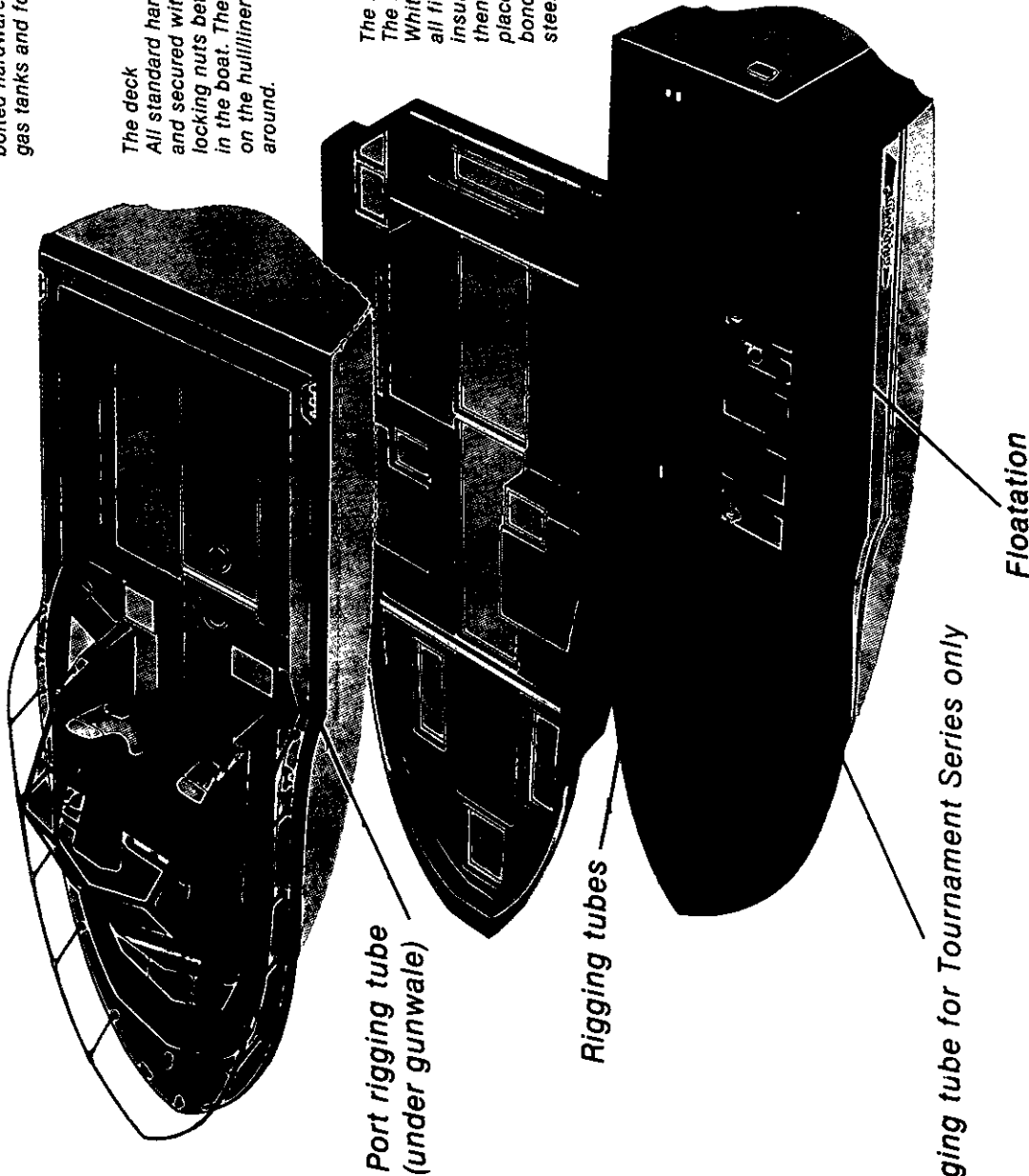

Port rigging tube  
(under gunwale)

Rigging tubes

Rigging tube for Tournament Series only

Floatation

**HULL/LINER/DECK LAYOUT**

## COMMONLY USED NAUTICAL TERMS

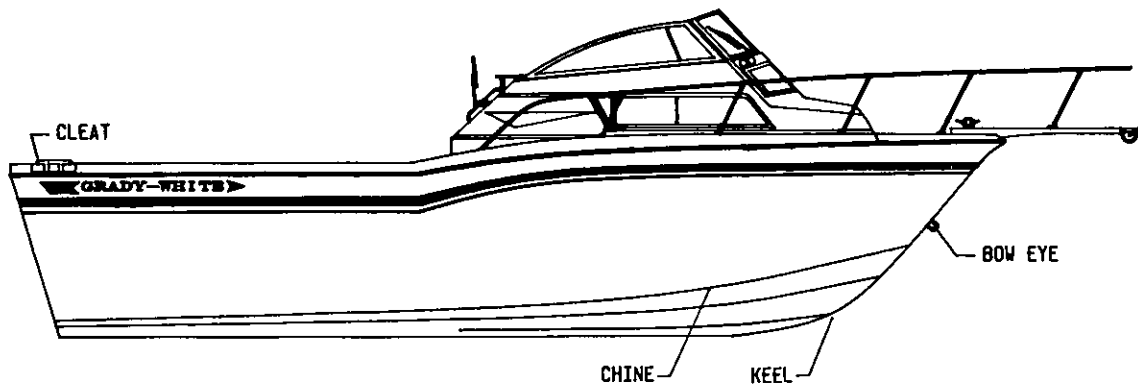
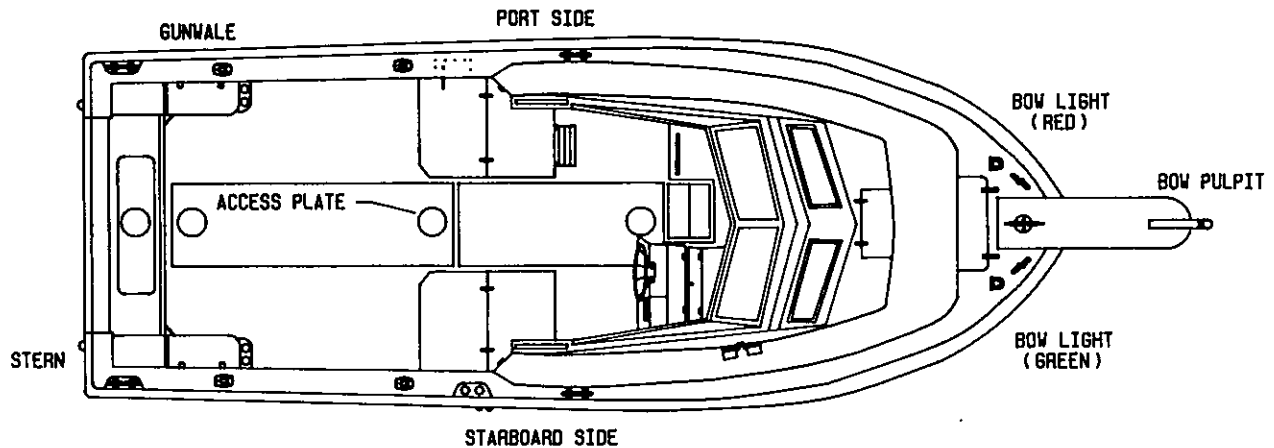

**ABEAM** – A line perpendicular to a boat's keel

**ACCESS PLATE** – A removable, watertight cover that provides quick entry to enclosed areas for maintenance or visual inspection

**AFT** – Toward the rear or stern of the boat

**BEAM** – The greatest width of a boat

**BILGE** – The lower interior area of the hull

**BOW** – The fore part of a boat

**BOW EYE** – A U-shaped hull fitting used to attach the trailer winch to the boat

**BULKHEAD** – Vertical partition in a boat

**CHINE** – Meeting juncture of topside and bottom of boat

**CLEAT** – Deck fitting with arms or horns on which lines are fastened

**DECK** – Upper structure which covers the hull

**DRAFT** – depth of water required to float a boat

**FATHOM** – A depth measurement equal to six feet

**FREEBOARD** – Height of topside from water line to the deck

**HATCH** – An opening in the deck to provide access below

**HEAD** – A toilet or toilet area in a boat

**HEADROOM** – Vertical distance between the deck and cabin or canopy top

**HULL** – The basic part of the boat; a watertight vessel that provides buoyancy to float the weight of the craft and its load

**KEEL** – The major longitudinal member of a hull – the lowest external portion of a boat

**KNOT** – Unit of speed in nautical miles per hour

**LEEWARD** – Away from the direction from which the wind is blowing (with the wind)

**LIST** – The tilt or lean to one side

**PORT** – A term designating the left side of the boat when facing forward

**SCUPPER** – Holes permitting water to drain overboard from deck or cockpit

**SHEER** – Curver or sweep of the deck as viewed from the side

**STARBOARD** – A term designating the right side of the boat when facing forward

**STERN** – The rear end of a boat

**STRINGER** – Longitudinal members fastened inside the hull for additional structural strength

**WAKE** – The track or path left in the water by a moving boat

**WINDWARD** – Toward the direction from which the wind is blowing (against the wind)



# 192 LIVEWELL LAYOUT

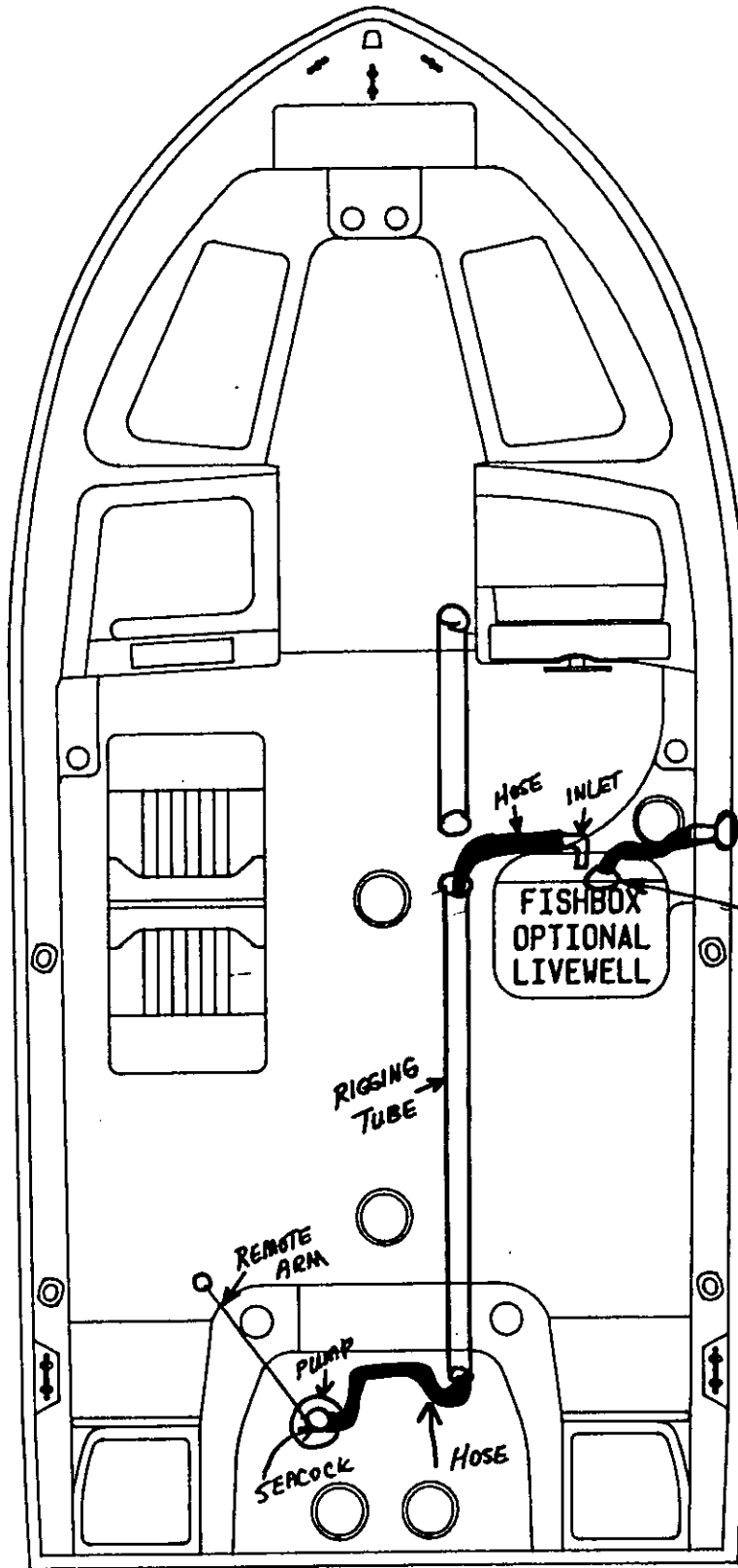

- NOTE:
- 1) MUST ADD 4" ACCESS PLATE TO FRONT OF BOX FOR ACCESS TO INLET AND OVERFLOW
  - 2) ADD GASKET AND SWIVEL HASP TO BOX LID TO PREVENT WATER FROM SLOSHING OUT

OVERFLOW THRU-HULL OVERFLOW

FISHBOX  
OPTIONAL  
LIVEWELL

RIGGING  
TUBE

REMOTE  
ARM

PUMP

SERCOCK

HOSE

SK-19-011  
6/9/94



# INDEX

## **A**

AC Wiring Schematic and Warning Label.....	68
Accessory Switches.....	15
Accessory Wiring Diagram	
175 Spirit.....	44
192 Tournament.....	45
208 Adventure.....	47
209 Escape.....	49
223/225G Tournament.....	51
226/227/228G Seafarer.....	53
230/231/232G/232GT Gulfstream.....	55
243 Chase.....	56-1
244/245/246G/246GT Explorer.....	57
250/251/253GT Dolphin.....	62
Accidents.....	9
Anchoring.....	23
Auxiliary Fuse Panel.....	16

## **B**

Battery.....	35, 39
Battery Select Switch.....	13
Bilge Pump Switch.....	14
Blower Switch.....	14

## **C**

Canvas.....	32-33
Carbon Monoxide.....	10
Cavitation.....	29
Certification Tag 243 Chase.....	11-1
Coast Guard Capacity Information Plate.....	10-11
Cockpit Light Switch.....	14
Commonly Used Nautical Terms.....	72
Compass.....	38

## **D**

Deck Pump-out.....	39-40
Docking.....	24
Dockside Power Wiring Diagram	
250/251/253GT Dolphin.....	65
Duratrим Maintenance.....	33

## **E**

Engine.....	34, 37
-------------	--------

## F

Fiberglass Finish.....	30-31
Fire Extinguisher.....	7
Fresh Water System Diagram	
192 Tournament.....	46
208 Adventure.....	48
209 Escape.....	50
223/225G Tournament.....	52
226/227/228G Seafarer.....	54
230/231/232G/232GT Gulfstream.....	56
243 Chase.....	56-2
244 Explorer.....	58
245 Explorer.....	59
246G Explorer.....	60
246GT Explorer.....	61
250/253GT Dolphin.....	63
251 Dolphin.....	66
Fuel Gauge.....	12
Fueling.....	19
Fuel System Maintenance.....	20
Fuel Tank Drainage.....	70
Fuel Tank Switch.....	14
Fuse Sizes.....	41

## G

Gelcoat.....	30-32
Grady Drives.....	34

## H

Hardtop Wiring Diagram	
20'/22'/23'/24' Series.....	66
25' Dolphin Series/252 Sailfish.....	65
Hardware Maintenance.....	33
Hardware Mounting.....	34
Head Operation.....	39-40
Horn.....	7, 15
Hydraulic Steering.....	17

## I

Instrument and Switch Panel Wiring Diagram	
Outboards.....	42
Stern Drives.....	43
Instrument Panel.....	12-13
Interior Maintenance.....	32

## L

Launch.....	22
Lighting.....	8
Livewell Switch.....	15
Load Distribution.....	20,29
Loading Capacity.....	11

## M

Mechanical Steering.....	17
--------------------------	----

## N

Navigation/Anchor Lights.....	15
-------------------------------	----

## O

Oil Level Gauge.....	12
Oil Pressure Gauge.....	12
Overboard Discharge.....	39-40

## P

Personal Flotation.....	7
Propeller.....	29

## R

Recovery.....	23
Registration Numbers.....	7

## S

Scuppers.....	34
Stainless Steel Maintenance.....	33
Starting.....	22
Switch Panel.....	13-15

## T

Tachometer Gauge.....	12
Throttle/Shift Control.....	24-26
Tilt Steering.....	18
Tilt Switch.....	15

Trailering.....	21
Trim.....	26
Trim Gauge.....	12
Trim Switch.....	15
Trim Tabs.....	27-28
Trim Tab Switch.....	15
Trim Tab Pump Locations.....	29

**V**

Visual Distress Signals.....	7
Voltmeter.....	13

**W**

Washdown/Livewell System.....	69
Washdown Switch.....	15
Water Pressure Gauge.....	13
Water Pressure Switch.....	15
Water Tank Drainage.....	37
Water Temperature Gauge.....	12
Water Temperature, Oil Level, and Fuel System Warning Buzzer.....	13
Windshield Wiper(s).....	15
Wiring Color Codes.....	41

## LIMITED WARRANTY

**REGISTRATION OF PURCHASE:** The "Federal Boat Safety Act of 1971" requires all boat manufacturers to maintain a record of all first retail purchasers and their current address for the purpose of notification in case of defective parts or equipment, or in case of non-compliance with standards or regulations set forth by this act. Under the act, failure to complete and return your factory warranty card for our records will waive your right to notification of defect and/or repair at manufacturers expense.

### FIVE YEAR HULL WARRANTY

Grady-White warrants to the original retail purchaser of each new Grady-White Boat that under normal use the hull will be free from structural defects for a period of five years from the date of delivery to the original retail purchaser. Any structural defects covered by the warranty will be repaired free of charge at either the Grady-White factory in Greenville, North Carolina, or at an authorized Grady-White dealer location as elected by Grady-White. Transportation to and from the point of repair will be the responsibility of the owner with all repairs subject to prior written authorization by Grady-White Boats, Incorporated. **NO BOAT IS TO BE SENT TO THE GRADY-WHITE FACTORY WITHOUT SUCH WRITTEN AUTHORITY.**

### ONE YEAR MATERIAL AND WORKMANSHIP WARRANTY

Grady-White further warrants to the original retail purchaser of each Grady-White boat that under normal use it will be free from defects in workmanship and material for a period of 12 months from the date of delivery to the original retail purchaser. Necessary repairs under this warranty will be made free of charge at Grady-White's factory in Greenville, North Carolina or at an authorized Grady-White dealer as elected by Grady-White. **NO BOAT OR PART THEREOF IS TO BE SENT TO THE GRADY-WHITE FACTORY WITHOUT SUCH WRITTEN AUTHORITY.**

### EXCLUSIONS

This warranty specifically does not include the following:

1. Damage caused by abuse, negligence, vandalism, lack of maintenance, improper storage or accident.
2. Any statements, representations, or warranties given by dealer or other third persons other than those provided within this warranty.
3. Any unit which is part of a rental fleet, used for racing or commercial purposes.
4. The following consequential damages: a) loss of time; b) inconvenience; c) towing charges; d) expenses for travel, lodging, telephone, and gasoline; e) loss or damage to personal property or loss of revenue; f) loss of use of the boat.
5. This warranty specifically does not apply to engines, outdrives, propellers, controls, mechanical steering, bilge pumps, and any other part expressly warranted by the manufacturer thereof. In addition, also excluded are gel coat cracking, gel coat crazing, gel coat blistering or fading, chrome, windshields, glass breakage, all vinyl upholstery and canvas, instruments and gauges, and leakage around windshields, windows, hatches, and other apertures.
6. Any boat which has been overpowered according to the maximum Grady-White recommended engine horsepower specifications on the capacity plate affixed to the boat.

### WARRANTY CLAIM PROCEDURES

Upon the discovery of a defect, the owner is to promptly contact the Grady-White dealer, from whom the owner purchased the boat who will effect the corrective action under this warranty upon prior written authorization from Grady-White Boats, Incorporated.

**THESE WARRANTIES ARE EXPRESSLY MADE IN LIEU OF ALL OTHER WARRANTIES, DURATION OF ANY IMPLIED WARRANTY OF MERCHANTABILITY OR FITNESS FOR A PARTICULAR PURPOSE OR OTHERWISE SHALL BE LIMITED TO AND COINCIDENT WITH THE DURATION OF THESE EXPRESSED WARRANTIES.**

**THIS WARRANTY SHALL NOT BE VALID UNLESS THE FACTORY WARRANTY POSTCARD IS PROPERLY EXECUTED AND MAILED WITHIN 10 DAYS OF THE PURCHASE OF YOUR GRADY-WHITE BOAT.**

GRADY-WHITE BOATS, INC.  
P.O. Box 1527  
Greenville, N.C. 27834

Customer Service: (919) 752-2111  
Monday-Friday  
8 am. to 5 pm. (EST)