



## Welcome Aboard!

Congratulations! Welcome to the proud and friendly Grady-White "family".

The Grady-White that you have purchased is the finest, safest, strongest boat that money can buy. All of us at Grady-White wish you many happy and carefree hours of boating in your Grady-White. Your boat was constructed by dedicated craftsmen in the most modern boat building facility in the United States

Your Grady-White boat meets or exceeds every safety standard of the U.S. Coast Guard and the National Marine Manufacturers Association's BIA Certification Program. Boating safety however, depends on the operation, maintenance and care of your boat. So a great deal of time and thought has gone into preparing this owner's manual. It includes precautions, facts and tips that will help make your boating safe, enjoyable and carefree. Study this manual carefully!

My personal thanks to you for choosing Grady-White. All of us at the factory and your Grady-White dealer will do everything possible to merit your confidence in Grady-White Boats. Happy boating!

Sincerely yours,

Eddie Smith, Jr.  
President

| MODEL | CENTER-<br>LINE<br>LENGTH | BEAM<br>AMID-<br>SHIP | AVAIL.<br>TRANSOM              |                  | HULL<br>DRAFT | O/B<br>MAX<br>H.P. | MAIN<br>FUEL<br>CAP.<br>(GAL) | AUX<br>FUEL<br>CAP.<br>(GAL) | FRESH<br>WATER<br>CAP.<br>(GAL) | APPROX<br>HEIGHT<br>KEEL TO<br>TOP OF W/S* |
|-------|---------------------------|-----------------------|--------------------------------|------------------|---------------|--------------------|-------------------------------|------------------------------|---------------------------------|--|
|       |                           |                       | HEIGHTS<br>(S-SGL)<br>(T-TWIN) | TRANSOM<br>WIDTH |               |                    |                               |                              |                                 |  |
| 170   | 16'10"                    | 81"                   | 20" S                          | 77"              | 12"           | 125                | 30                            |                              |                                 | 60.5"                                      |
| 190   | 18'11"                    | 96"                   | 20" S                          | 92"              | 14"           | 200                | 40                            |                              |                                 | 71.5"                                      |
| 197   | 18'11"                    | 96"                   |                                | 92"              | 14"           |                    | 40                            |                              |                                 | 71.5"                                      |
| 198   | 18'11"                    | 96"                   |                                | 92"              | 14"           |                    | 40                            |                              |                                 | 71.5"                                      |
| 204   | 20' 4"                    | 96"                   | 25S/20T                        | 94"              | 14"           | 230                | 80                            |                              |                                 | 78"  |
| 204C  | 20' 4"                    | 96"                   | 25S/20T                        | 94"              | 14"           | 230                | 65                            |                              |                                 | 80.2"                                      |
| 205   | 20' 4"                    | 96"                   |                                | 94"              | 14"           |                    | 65                            |                              |                                 | 83.3"                                      |
| 206   | 20' 4"                    | 96"                   |                                | 94"              | 14"           |                    | 65                            |                              |                                 | 83.3"                                      |
| 223   | 22' 0"                    | 96"                   | 25S/20T                        | 94"              | 14"           | 280                | 95                            | 40                           |                                 | 79"  |
| 224   | 22' 0"                    | 96"                   |                                | 94"              | 14"           |                    | 95                            | 40                           |                                 | 79"  |
| 225   | 22' 0"                    | 96"                   |                                | 94"              | 14"           |                    | 95                            | 40                           |                                 | 79"  |
| 226   | 22' 0"                    | 96"                   | 25S/20T                        | 94"              | 14"           | 280                | 95                            | 40                           |                                 | 93"  |
| 227   | 22' 0"                    | 96"                   |                                | 94"              | 14"           |                    | 95                            | 40                           |                                 | 93"  |
| 228   | 22' 0"                    | 96"                   |                                | 94"              | 14"           |                    | 95                            | 40                           |                                 | 93"  |
| 240   | 24' 1"                    | 96"                   | 25S/20T                        | 94"              | 16"           | 280                | 95                            | 55                           |                                 | 93"  |
| 241   | 24' 1"                    | 96"                   |                                | 94"              | 16"           |                    | 95                            | 55                           |                                 | 93"  |
| 242   | 24' 1"                    | 96"                   |                                | 94"              | 16"           |                    | 95                            | 55                           |                                 | 93"  |
| 243   | 24' 1"                    | 96"                   | 25S/20T                        | 94"              | 16"           | 280                | 95                            | 55                           |                                 | 85"  |
| 244   | 24' 1"                    | 96"                   |                                | 94"              | 16"           |                    | 95                            | 55                           |                                 | 85"  |
| 245   | 24' 1"                    | 96"                   |                                | 94"              | 16"           |                    | 95                            | 55                           |                                 | 85"  |
| 252   | 25' 4"                    | 114"                  |                                | 108"             | 19"           |                    | 125                           | 73                           | 25                              | 102"                                       |
| 254   | 25' 4"                    | 114"                  |                                | 108"             | 19"           |                    | 125                           |                              | 25                              | 102"                                       |
| 255   | 25' 4"                    | 114"                  | 25S/25T                        | 108"             | 19"           | 400                | 125                           | 73                           | 25                              | 102"                                       |
| 257   | 25' 4"                    | 114"                  | 25T                            | 108"             | 19"           | 400                | 150                           | 73                           | 15                              | 100"                                       |
| 258   | 25' 4"                    | 114"                  |                                | 108"             | 19"           |                    | 150                           |                              | 15                              | 100"                                       |
| 259   | 25' 4"                    | 114"                  |                                | 108"             | 19"           |                    | 150                           | 73                           | 15                              | 100"                                       |

\* WITH HARDTOP ADD 21"

MODEL: \_\_\_\_\_

SERIAL NUMBER: \_\_\_\_\_

ENGINE OPTION: \_\_\_\_\_

FACTORY INSTALLED PROP (ALUM): \_\_\_\_\_

STEERING: \_\_\_\_\_

CONTROL CABLE LENGTHS: \_\_\_\_\_

STEERING CABLE LENGTH: \_\_\_\_\_

\*\* APPROX. WEIGHT  
(W/O ACCESSORIES): \_\_\_\_\_

\*\* OUTBOARD WEIGHTS DO NOT INCLUDE ENGINE

DEALER: \_\_\_\_\_

OWNERS NAME: \_\_\_\_\_

OWNERS ADDRESS: \_\_\_\_\_

# TABLE OF CONTENTS

WELCOME ABOARD  
DATA SPECIFICATION SHEET

## Safety

|                             |        |
|-----------------------------|--------|
| GOVERNMENT REGULATIONS..... | PAGE 5 |
| RULES OF THE ROAD .....     | PAGE 7 |
| LOADING .....               | PAGE 9 |

## Instruments and Controls

|  |         |
|--|---------|
| INSTRUMENTS AND GAUGES .....           | PAGE 10 |
| Tachometer .....                       | PAGE 10 |
| Engine Water temperature gauge.....    | PAGE 11 |
| Water temperature warning buzzer ..... | PAGE 11 |
| Voltmeter .....                        | PAGE 11 |
| Trim gauge .....                       | PAGE 11 |
| Fuel gauge .....                       | PAGE 11 |
| Oil pressure gauge .....               | PAGE 11 |
| Ignition switch .....                  | PAGE 11 |
| Trim/Tilt switch .....                 | PAGE 12 |
| Trim tab switch .....                  | PAGE 12 |
| Bilge pump switch.....                 | PAGE 13 |
| Blower switch .....                    | PAGE 13 |
| Horn button .....                      | PAGE 13 |
| Cockpit light switch .....             | PAGE 13 |
| Nav/Anchor light switch .....          | PAGE 13 |
| Fuel switch .....                      | PAGE 14 |
| Aerator switch .....                   | PAGE 14 |
| Washdown pump switch .....             | PAGE 14 |
| Water pressure switch .....            | PAGE 14 |
| Windshield wiper switch .....          | PAGE 14 |
| Battery select switch .....            | PAGE 14 |
| Battery isolator .....                 | PAGE 15 |
| Auxiliary fuse panel .....             | PAGE 15 |

## Mechanical Controls

|                              |         |
|------------------------------|---------|
| STEERING .....               | PAGE 16 |
| THROTTLE/SHIFT CONTROL ..... | PAGE 17 |
| TROUBLE SHOOTING .....       | PAGE 18 |
| TRIM TABS .....              | PAGE 19 |

## Boat Operation

|                   |         |
|-------------------|---------|
| FUELING .....     | PAGE 20 |
| PROPELLERS .....  | PAGE 22 |
| TRAILERING .....  | PAGE 23 |
| PRE-LAUNCH .....  | PAGE 24 |
| STARTING .....    | PAGE 24 |
| PERFORMANCE ..... | PAGE 25 |
| ANCHORING .....   | PAGE 26 |
| DOCKING .....     | PAGE 27 |

### Maintenance and Care

|                            |         |
|----------------------------|---------|
| FIBERGLASS FINISH .....    | PAGE 28 |
| GELCOAT REPAIR .....       | PAGE 29 |
| INTERIOR MAINTENANCE ..... | PAGE 30 |
| CANVAS .....               | PAGE 30 |
| TEAK .....                 | PAGE 30 |
| HARDWARE .....             | PAGE 30 |
| HARDWARE MOUNTING .....    | PAGE 31 |
| BATTERY .....              | PAGE 31 |
| SCUPPERS .....             | PAGE 32 |
| ENGINE .....               | PAGE 32 |
| STORAGE .....              | PAGE 32 |

### Electrical Systems

|  |         |
|--|---------|
| FUSE SIZES .....   | PAGE 33 |
| WIRING COLOR CODES AND SIZES (ACCESSORIES) .....                     | PAGE 33 |
| INSTRUMENT AND SWITCH PANEL WIRING DIAGRAM (TYPICAL OUTBOARD).....   | PAGE 34 |
| INSTRUMENT AND SWITCH PANEL WIRING DIAGRAM (TYPICAL OMC SEA DRIVE) . | PAGE 35 |
| INSTRUMENT AND SWITCH PANEL WIRING DIAGRAM (TYPICAL STERN DRIVE) ... | PAGE 36 |
| ACCESSORY WIRING DIAGRAM 17'-19' TOURNAMENT SERIES .....             | PAGE 37 |
| ACCESSORY WIRING DIAGRAM 204 FISHERMAN .....                         | PAGE 38 |
| ACCESSORY WIRING DIAGRAM 20' OVERNIGHTER SERIES .....                | PAGE 39 |
| ACCESSORY WIRING DIAGRAM 22'-24' TOURNAMENT SERIES .....             | PAGE 40 |
| ACCESSORY WIRING DIAGRAM 22' SEAFARER & 24' OFFSHORE SERIES .....    | PAGE 41 |
| ACCESSORY WIRING DIAGRAM 25' SAILFISH SERIES .....                   | PAGE 42 |
| ACCESSORY WIRING DIAGRAM 25' TROPHY SERIES .....                     | PAGE 43 |
| HARDTOP WIRING DIAGRAM .....   | PAGE 44 |
| DOCKSIDE POWER ROUTING DIAGRAM .....                                 | PAGE 45 |

### Water Systems

|   |         |
|---|---------|
| FRESH WATER SYSTEM (UNPRESSURIZED) FOR 25' SAILFISH SERIES .....    | PAGE 46 |
| SHOWER & HOT WATER SYSTEM (PRESSURIZED) FOR 25' SAILFISH SERIES ... | PAGE 47 |
| FRESH WATER SYSTEM (25 TROPHY) .....                                | PAGE 48 |
| WASHDOWN/LIVEWELL SYSTEM .....                                      | PAGE 49 |

### General Construction

|                              |         |
|------------------------------|---------|
| HULL/DECK/LINER LAYOUT ..... | PAGE 50 |
| NAUTICAL TERMS .....         | PAGE 51 |
| WARRANTY .....               | PAGE 52 |

## **Required Safety Equipment and Additional Recommended Equipment**

The U.S. Coast Guard requires that every boat has on board specific equipment which varies according to the size of the boat. There are also local agencies which require additional equipment, so find out if your local regulations require more equipment than the list of Coast Guard requirements below.

As your Grady-White is between 16 and 26 feet, it is classified as a Class 1 boat and requires the following safety equipment:

1. **FIRE EXTINGUISHER**

Your fire extinguisher should be easily accessible and each passenger should be aware of its location.

2. **PERSONAL FLOATATION**

Each passenger (and skier) must have a U.S. Coast Guard approved personal floatation device. They should be stored where they can be reached easily and quickly. Small children and nonswimmers should wear these floatation devices at all times. Each Class 1 boat is also required to carry an approved Type 4 throwable floatation device such as a ring bouy or boat cushion.

3. **HORN**

All Class 1 boats are required to carry a hand, mouth or power-operated horn that is audible for at least one mile.

4. **VISUAL DISTRESS SIGNALS**

Coast Guard-approved visual distress signals are now required when operating in U.S. waters and on the high seas. The Coast Guard pamphlet "Visual Distress Signals for Recreational Boats" tells you the equipment necessary.

5. **REGISTRATION NUMBERS**

Federal and state laws require that a power boat be registered in the state where it is principally used. Both registration numbers and validation stickers must be displayed according to the regulations and the registration certificate must be carried on board. The boat's serial number, required on the registration form, is found on the upper right hand corner of the transom.

6. **LIGHTING**

All Grady-Whites are equipped with navigational lights which meet the latest requirements for inland and international waters. If there is any doubt, or if requirements change, consult your dealer.

For more information on Coast Guard required safety equipment refer to the U.S. Coast Guard publication CG-290.

In addition to required safety equipment, we also recommend the following:

ADDITIONAL RECOMMENDED EQUIPMENT

|                                 |  |
|---------------------------------|--|
| Anchor and anchor line          | Hand operated bilge pump   |
| Sea anchor                      | Extra keys   |
| Tow line                        | Boat hook  |
| Fenders (2)                     | Extra drain plug   |
| Mooring lines (4)               | Oar or paddle  |
| Spotlight or flashlight         | Insect repellent   |
| Spare fuses                     | Drinking water   |
| First aid kit                   | Sun screen   |
| Compass and navigational charts | Brush, Bucket and sponge   |
| Marine electronics              | Tool kit including: adjustable wrench, slip-joint pliers, spark plug wrench and spark plugs, screwdrivers (slotted & phillips'), box end wrench set, hammer, roll of soft wire, electricians tape, knife, spare propeller & prop nut, and spare hydraulic fluid. |

## Rules of the Road

The following "rules of the road" will add to your safety and boating convenience:

1. Advise someone on shore or the local Coast Guard as to the name of your launch site, your expected direction and expected return.
2. Watch the weather. You should not attempt to go out when there are storm or small craft warnings. If you are caught in a storm, reduce speed, head into the wind/waves and keep all gear and passengers close to the centerline of the boat for stability. Head for the nearest shelter.
3. Instruct at least one passenger on the fundamentals of operating your boat in case of any emergency.
4. Report any boating accident to the local authorities whether you are involved or not.

### IN CASE OF ACCIDENT

\*\*\*\*\*

If you are involved in a boating accident on the navigable waters of the U.S., you are required by law to stop and render assistance. You are also required to identify yourself and your boat to the injured person or owner of the damaged property. An accident report must be filed for accidents of over \$100 property damage with proper authorities within five days of the accident. If the accident results in death, disappearance or injury requiring medical attention, an accident report must be filed within 48 hours. Report forms may be obtained through Coast Guard installations, most harbor patrol offices, and many sheriff's and police stations.

\*\*\*\*\*

5. If you develop trouble and do not have a radio, the regulation distress signal is continually raising and lowering your arms outstretched at your sides. Other signals include waving a shirt tied to a pole, repeatedly sounding your horn or flying your boat's ensign upside down and lighting flares.
6. If your boat is equipped with canvas which encloses the aft cockpit and the propulsion equipment, do not operate the boat with this canvas closed. The fumes from the engine create a health hazard.
7. Keep your boat speed under control. Respect for other boaters and those on shore is common courtesy. In addition, the operator is responsible for any injury or damage caused by the boat's wake. Your wake could swamp or damage a smaller craft and endanger its passengers. Stay alert to areas having signs posted "No Wake Zones".

8. *Be prepared to give assistance to other boats in distress.*
9. *Become familiar with the handling characteristics, capabilities and limitations of your boat.*
10. *Turn off engines before swimmers enter or exit the boat. A shift lever in neutral could become engaged accidentally, injuring swimmers seriously.*
11. *Consult with people familiar with the boating area when venturing into unknown waters. Obtain a chart for new areas whenever possible.*
12. *Since clean water and air are the responsibilities of everyone, carry a litter container on board and dispose of refuse properly. If your Grady-White is equipped with a marine head, become familiar with local laws regarding discharge of waste.*
13. *Recommend boat shoes or tennis shoes to your passengers rather than street shoes or bare feet.*





## Loading Capacity

Close to the steering wheel, you will find a Coast Guard Capacity Information metal tag indicating the maximum weight and people capacity of your boat. If you have a outboard boat, the tag will also designate the maximum horsepower capacity. You and your passengers will be in jeopardy and your warranty void if either of these requirements are exceeded.

Though overloading is a primary cause of boating accidents, improper loading is equally as hazardous. The load your boat will carry is not necessarily indicated by the weight it is carrying.

The capacity plate does not relieve the boatman from the responsibility of sound judgement. Rough water and adverse conditions can reduce the boat's capacity, so you should maintain a watch on weather conditions.



Example: 190 Tournament Capacity Plate

LOAD AND H.P. CAPACITY ● LEVEL FLOTATION  
STEERING, FUEL AND ELECTRICAL SYSTEMS  
COMPARTMENT VENTILATION ● NAVIGATION LIGHTS



NATIONAL MARINE MANUFACTURERS ASSN.

This tag, provided by the National Marine Manufacturers Association, means that your Grady-White is BIA certified. This means your fuel system, lighting, ventilation, steering, floatation, capacities and horsepower ratings not only are in compliance with the U.S. Coast Guard Regulations, but also meet the more stringent standards of the American Boat & Yacht Council.

The National Marine Manufacturers Association is a national trade organization serving all elements of the recreational boating industry including manufacturers of boating equipment. Their standards mean you can have confidence in the quality of your boat.



## Instruments and Switches

The instruments in stern drive and Sea Drive models are electrically connected to the ignition key and operate when the key is on. Fuel gauges on outboard models are electric, but not connected to the ignition so there is a separate switch to activate the fuel gauge.

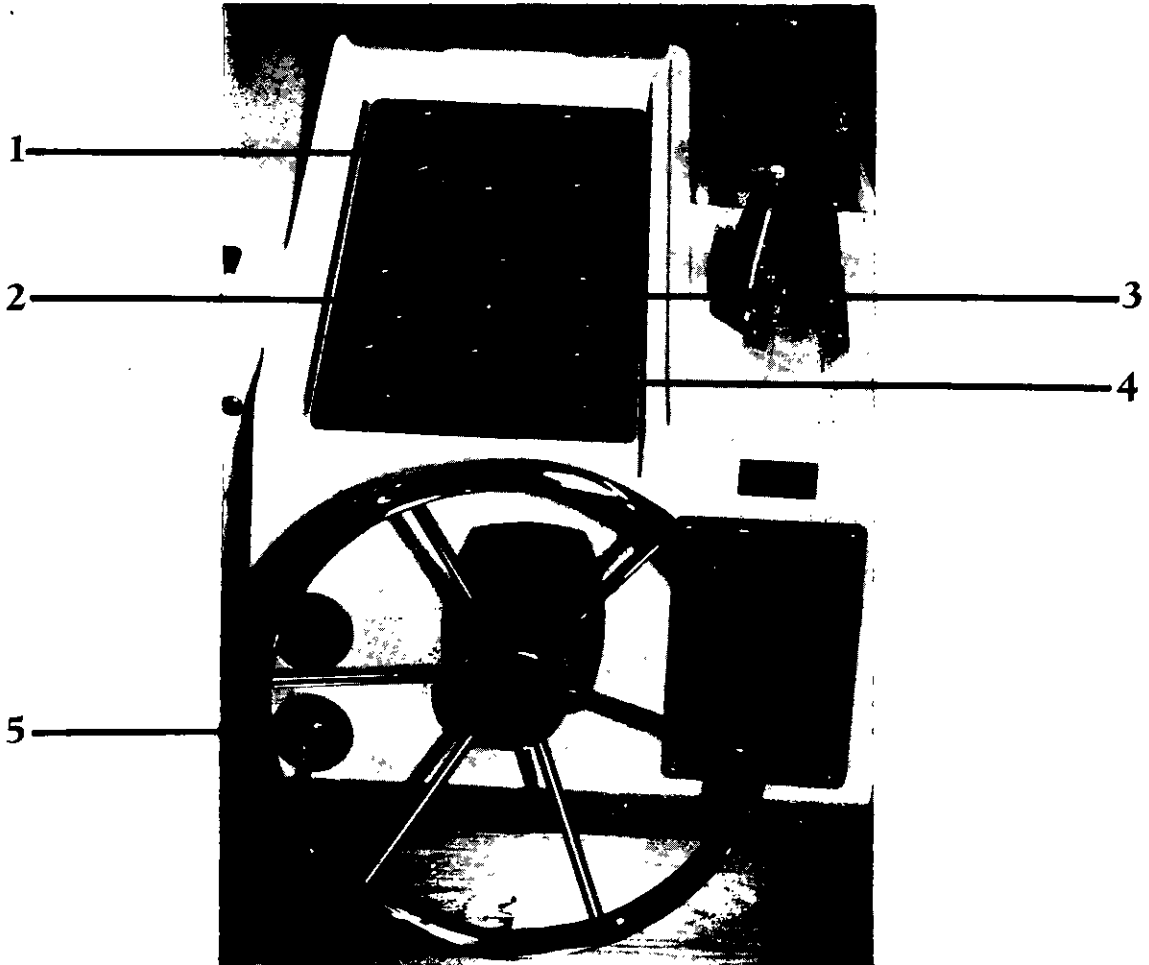

### 1. TACHOMETER GAUGE

Standard equipment on stern drive and Sea Drive models, the tachometer indicates engine revolutions per minute (RPM) in 100's. Consult your engine owner's manual for recommended operating RPM's.

**ENGINE WATER TEMPERATURE GAUGE (Not shown on diagram)**

Standard on stern drive models, this gauge indicates the temperature of the cooling water circulating through your engine. When the temperature exceeds the recommended operation range indicated by your engine owner's manual, immediately shut off your engine to prevent damage. Overheating is often caused by obstruction of your engine's intake on the lower unit. Check the intake first if you experience trouble.

**WATER TEMPERATURE WARNING BUZZER (Not shown on diagram)**

Sea drive models have a factory installed water temperature warning buzzer under the dash. Outboard models have a warning buzzer installed by the dealer which is in the throttle control or under the dash. This buzzer serves the same purpose as the water temperature gauge.

**2. VOLTMETER**

This meter indicates the battery charge. With the ignition "on", a reading of 12 or 13 volts is normal, indicating a fully-charged battery. Readings below 11 indicate a weak battery which may not start the engine(s). A reading of 13 to 15 volts when the engine is running is normal. Readings over 15 volts may indicate regulator problems. Low or fluctuating readings may indicate loose connections, loose belts, or trouble in the regulator and alternator circuit. A voltage drop soon after the engine is shut down indicates a bad battery or a heavy load on the electrical system.

**3. TRIM GAUGE**

This trim gauge is standard on all stern drive and Sea Drive models. This gauge indicates the angle of thrust of the lower unit of the engine(s). See the PERFORMANCE section of manual for trim adjustment recommendations.

**4. FUEL GAUGE**

This gauge indicates the gas tank fuel level. The electric sending unit senses the level of fuel and indicates this on the gauge. When reading this gauge, remember two things: (1) the accuracy of your gauge varies with the attitude of your boat in the water (trim or list) and (2) the fuel pick-up tube inside the gas tank is not capable of withdrawing all of the fuel from the tank. So never operate your boat at extremely low fuel levels.

**OIL GAUGE (Not shown on diagram)**

The oil gauge is standard on all stern drive models. This gauge indicates the oil pressure at the engine. Consult your engine owner's manual for proper operating ranges.

**5. IGNITION SWITCH**

The ignition switch is factory installed on all stern drive and Sea Drive models. In Sea Drive models, the choking system is combined with the ignition switch. The choke on Sea Drive models is engaged by pushing in the ignition key while turning the key at the same time.

**TRIM/TILT SWITCH**

Trim and tilt are standard on all Sea Drive and most stern drive models. The trim and tilt switches are located in the throttle control or as separate switches on the dash. The trim switch changes the angle of thrust of the engine (see PERFORMANCE section). The tilt switch raises the drive unit for trailering. In Sea Drive models, the tilt lock bracket (shown below) locks the drive unit in trailering position.

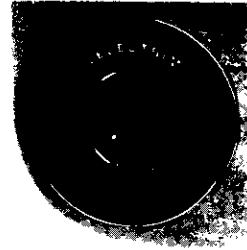

**Tilt lock bracket**

\*\*\*\*\*  
It is very important that the sea drive engines be locked in the trailering position or in the fully lowered position when trailering the boat.  
\*\*\*\*\*

**TRIM TAB SWITCH**

Trim tab switches control the optional trim tabs used for adjusting the attitude of the boat while running. (See TRIM TABS in the PERFORMANCE section).

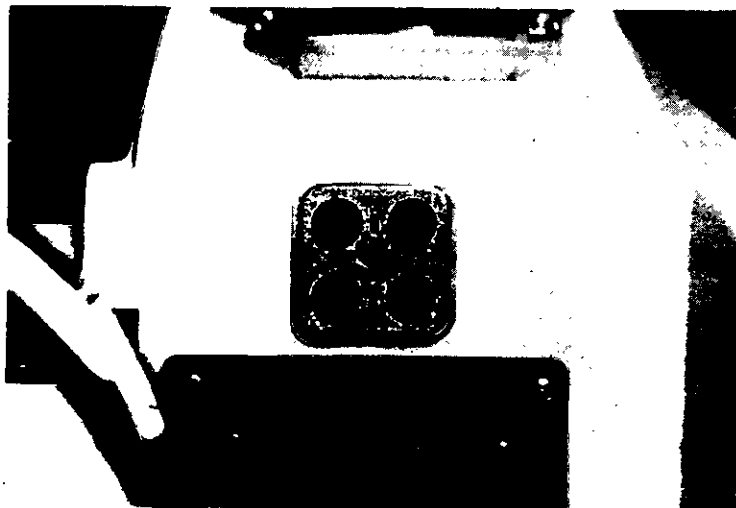

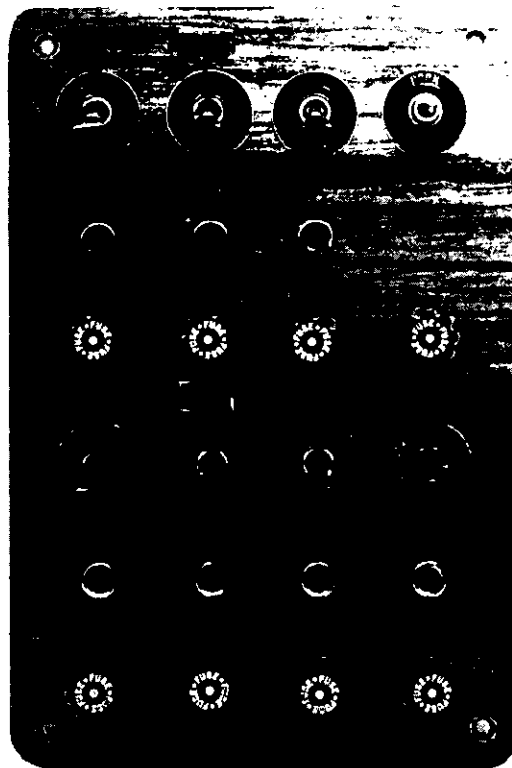

### **Switch Panel**

At the helm station you will find an accessory switch panel similar to the above picture. Auxiliary switches are noted below.

#### **BILGE PUMP**

3-way switch indicates whether the pump is in either the On, Off, or Standby position.

#### **BLOWER**

The blower is standard on stern drive models. The blower eliminates any gasoline fumes from the engine compartment and should be run at least 4 minutes before starting the engine and should be in operation when running slower than cruising speed.

#### **HORN**

The horn may be standard or optional.

#### **COCKPIT LIGHTS**

The cockpit lights may be standard or optional and are located in the cockpit area.

#### **NAVIGATIONAL/ANCHOR LIGHTS**

All models are equipped with lights meeting International or Inland lighting rules. The three position switch (NAV-OFF-ANCHOR) which changes the lighting configuration for running lights or anchoring lights.

**FUEL GAUGE**

The fuel gauge is standard in all outboard models. This switch must be in the "on" position for a reading. When there are dual tanks, a 3-position switch (MAIN-OFF-AUX) gives you separate readings for each tank.

**AERATOR**

The aerator may be either optional or standard.

**WASHDOWN**

The washdown system may be either optional or standard.

**WATER PRESSURE**

This switch activates the pressurized fresh water system.

**WINDSHIELD WIPER(S)**

The windshield wipers are optional on all boats.

**ACCESSORY**

Switches labeled "Accessory" are blank switches which are available for non-factory installed accessories.

**NOTE:** Most accessory switch panels have indicator lights and fuse holders for each switch. (See the Electrical Systems section for recommended fuse amperages.) Switch identification labels are available from your dealer for non-factory installed options.

**BATTERY SELECT SWITCH**

Standard on all twin Sea Drive installations, the battery select switch allows selection of either of the two batteries, both batteries, or neither of the batteries (disconnected). **NOTE:** Never turn the battery select switch to "Off" with the engine running as this could damage the charging system.

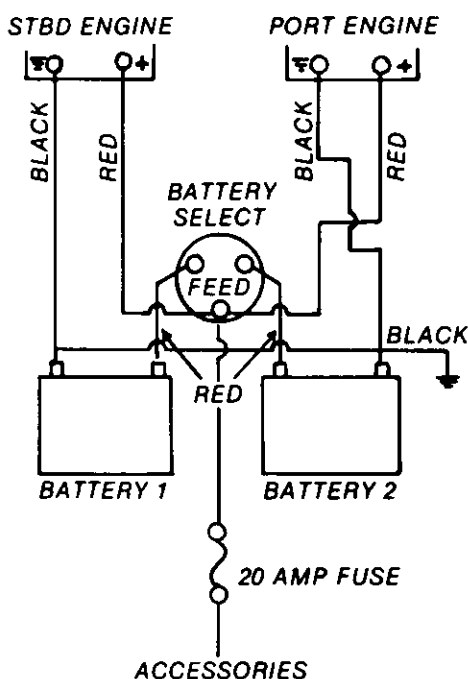

### BATTERY ISOLATOR

Standard on all twin Mercruiser engine installations, the isolator directs current flow in one direction only, permitting the alternator to directly connect the two batteries. This eliminates the possibility of a higher charge battery discharging into a lower charge battery. The isolator allows both batteries to be charged according to their respective need.

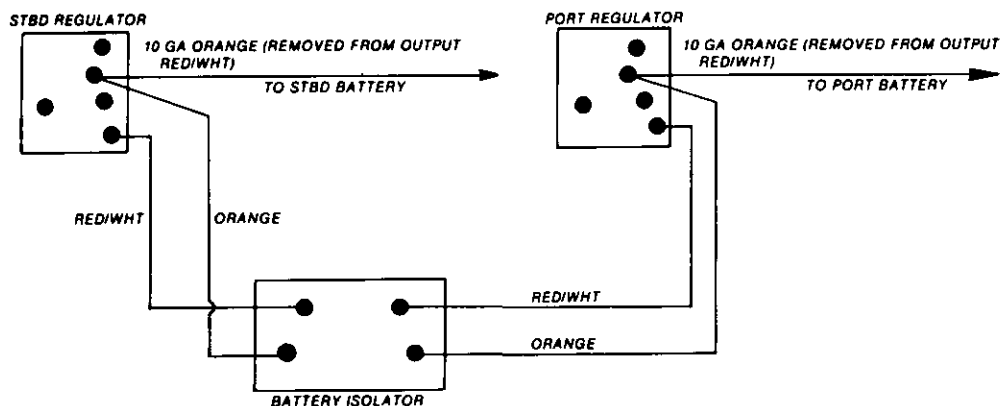

### AUXILIARY FUSE PANEL

Located under the dash, the auxiliary fuse panel offers the ability to hook additional electronics in excess of the extra accessory switches located in the dash. Note a set of 10 gauge wires (orange and black) running from the panel. These wires terminate at a junction box on the port side. This junction box offers convenient access to power for electronics installed on the port side. See the electrical diagrams for the location of the junction box.

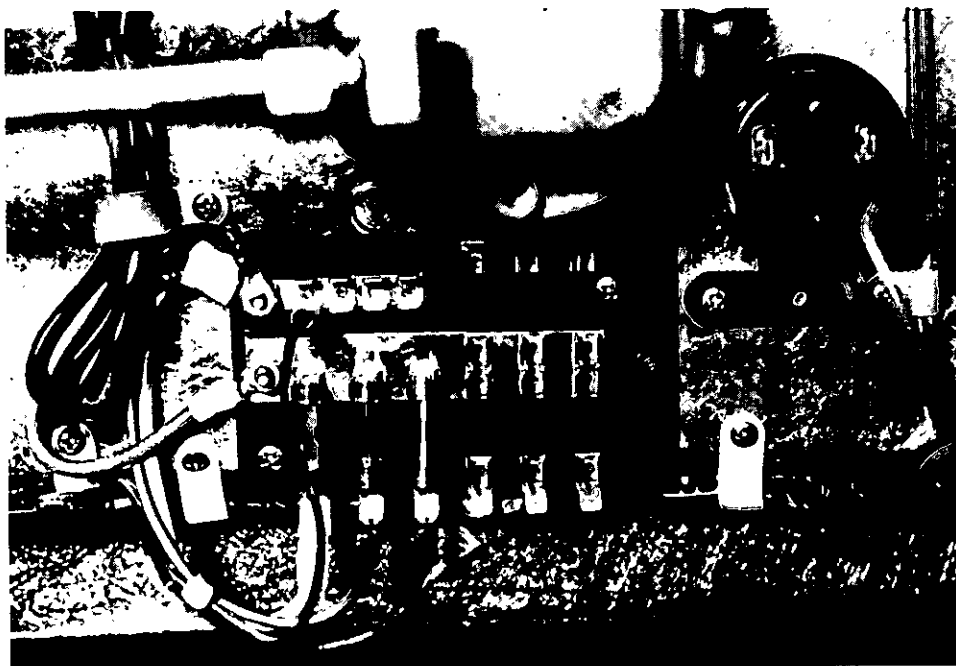

## Mechanical Controls

### MECHANICAL STEERING

The mechanical steering system is designed to require a minimum of maintenance. However, you should periodically inspect the complete steering system for wear, rust, or corrosion of the steering control heads, cable ends and attachments and lubricate the parts when needed. If you ever notice any change in the feeling of the system such as binding, looseness, noise or sticking, immediately perform a thorough inspection.

In outboard models, the push rod at the end of the cable is susceptible to freezing if improperly greased. When the boat is not in use, the motor should be turned so that the push rod is not exposed to the elements. If you operate in salt water areas lubrication is extremely important and you should make frequent inspections for corrosion.

### HYDRAULIC STEERING

The hydraulic steering systems (not to be confused with power steering) are completely self-lubricating. However, regular preventative maintenance as specified in the manufacturer's manual is needed for safe operation.

In systems with a hydraulic reservoir, refer to the manufacturer's manual for the proper operating pressure. Inspect the fluid level and pressure at the reservoir before every trip. Periodic inspections should include all the hydraulic lines and fittings for leakage, rust and corrosion. All lines and hoses should be free from friction and extreme heat from adjoining parts. Tighten fittings and clamps as needed.

Most sea drive models have a hydraulic system with the hydraulic pump at the helm. Refer to the manufacturer's manual for instruction on periodic inspections. Two brass tees have also been installed to assist in bleeding the system if necessary. These tees are located at the stern where the copper tubing terminates.

NOTE: All repairs and replacements to steering systems should be made only by an authorized dealer.



## THROTTLE/SHIFT CONTROL

The throttle/shift control, located at the helm station, controls the flow of fuel to the engine and acts as a gear shift lever to control the forward and aft thrust of the propeller.

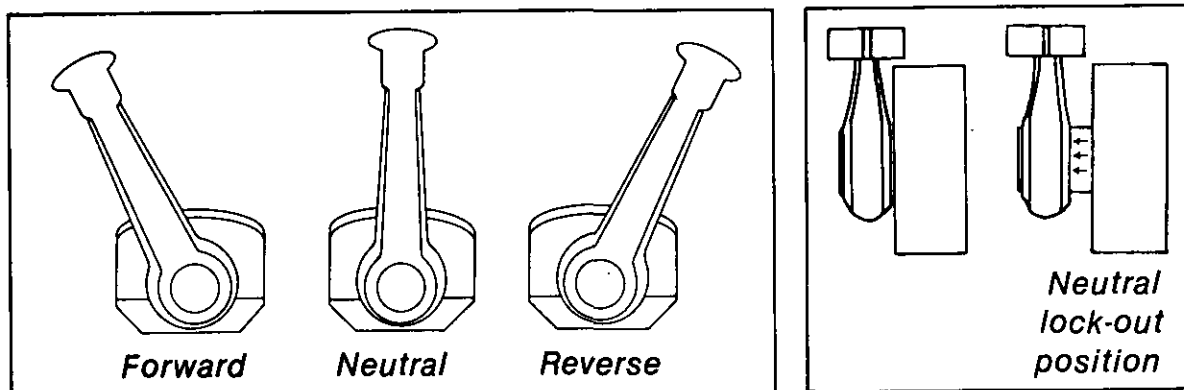

The vertical position of the throttle control is normally the neutral position. Move the control forward to engage the shifting mechanism which creates a forward thrust of the propeller. Increase the forward movement to increase the fuel flow to the engine and increase the forward thrust.

Move the control lever aft of the neutral position to reverse the shift mechanism to create a reverse thrust of the propeller. Increase the aft movement to increase the reverse thrust.

All controls have a safety mechanism which does not allow the engine to start when the control is in gear. In order to increase the flow of fuel to the engine while remaining in the neutral position, you may use the neutral lock out button in the control handle.

You may reverse the shift mechanism in order to provide a "braking action", slowing the boat. This braking action causes a following wake which may rise above the transom and flood the boat if the boat is moving at too great a speed, so exercise caution. Propellers are designed for maximum forward thrust, so reverse thrust will not be as efficient.

The control head at the helm should be cleaned and kept free of corrosion. Periodically check the mounting for loose screws. Also check the cable conduit for cracks, abrasions, or kinked or bent cable. Replace damaged cable (see your dealer).

The cable ends and cable fittings should be checked periodically for corrosion, loose brackets and loose, worn or damaged fittings. Replace worn or damaged parts. Cable ends, fittings and the control mechanism may be sprayed with a moisture-displacing lubricant. If your control has "quick disconnect" fittings, inspect the springs for corrosion. Should your throttle or shift cables need replacing, the data sheet at the front of this manual will indicate the lengths required.

Many throttle controls are equipped with trim buttons in the handle. Refer to the PERFORMANCE section for instructions on trim.

## Trouble Shooting

### ENGINE CONTROL

| SYMPTON   | CHECK POINTS  |
|---|---|
| <i>Engine starter does not engage when lever is in neutral position.</i>          | <ol style="list-style-type: none"> <li>1. Neutral start switch not properly adjusted.</li> <li>2. Neutral start switch malfunctioning or stuck.</li> <li>3. Dead battery or loose electrical connection.</li> </ol>   |
| <i>Control becomes stiff or unusually hard operating, jerky and erratic</i>       | <ol style="list-style-type: none"> <li>1. Control cable(s) are crushed, kinked or bent too sharply.</li> <li>2. Cable(s) are corroded at ends or are clogged internally with dirt and grime.</li> <li>3. Engine shift or throttle linkage not working properly.</li> <li>4. Remote control mechanism is defective, faulty or has been damaged internally.</li> <li>5. Foreign objects interfering with throttle or shift mechanism at either control head or engine.</li> </ol> |
| <i>Throttle and shift does not respond properly to control hand lever.</i>        | <ol style="list-style-type: none"> <li>1. Cable ends and connection fitting not properly secured at the engine or control head.</li> <li>2. Wear in the control mechanism or excessive backlash caused by too many bends in the push-pull cable(s) conduit.</li> <li>3. Control system not properly adjusted.</li> </ol>  |
| <i>Engine starter engages remote control hand lever is in forward or reverse.</i> | <ol style="list-style-type: none"> <li>1. Neutral start switch not properly adjusted.</li> <li>2. Neutral start switch malfunctioning or stuck in "closed" position.</li> <li>3. Faulty wiring.</li> </ol>  |

### PUSH-PULL CABLE STEERING

| SYMPTON  | CHECK POINTS  |
|--|---|
| <i>Steering stiff or unusually hard operating, jerky or erratic.</i>   | <ol style="list-style-type: none"> <li>1. Corrosive deposits at cable output end, either inside cable sleeve or inside motor tilt tube.</li> <li>2. Crushed or kinked cable conduit.</li> <li>3. Bent cable ram at output end.</li> <li>4. Friction device at helm over-tightened.</li> <li>5. Internal corrosion or damage to cable.</li> <li>6. Engine and boat not "Trimmed out" properly.</li> <li>7. Engine trim tab loose, damaged or incorrectly set.</li> <li>8. Transom bracket improperly mounted, bent or distorted. (Boat mounted systems only.)</li> <li>9. Bent or distorted engine link may be interfering with engine. (Motor mounted systems only.)</li> </ol> |
| <i>Steering sloppy and has excessive free steering wheel movement.</i> | <ol style="list-style-type: none"> <li>1. Cable transom bracket loose or cable and fittings loose or badly worn.</li> <li>2. Steering wheel loose on helm.</li> <li>3. Worn or loose fasteners in helm unit or drive unit.</li> <li>4. Worn push-pull cable.</li> </ol>   |
| <i>Steering system won't turn.</i>                                     | <ol style="list-style-type: none"> <li>1. Corrosive buildup at output end of cable.<br/><b>WARNING: If the system does not free easily, replace the steering cable.</b></li> <li>2. System badly damaged at the helm or cable output end.</li> </ol>  |

## TRIM TABS

Trim tabs are electrically-hydraulically operated and used to regulate the attitude of the boat while underway. They may also be used to adjust the boat's running angle in adverse seas or to compensate for unusual load conditions.



The trim tabs are operated by a four button panel switch and will aid in trimming the boat fore and aft for a smoother ride.

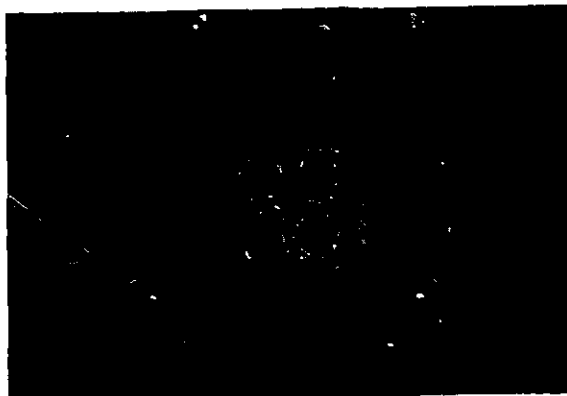

The switches are marked "bow up" and "bow down". Trim tabs in the extreme bow up positions will have no effect on the boat's ride.

Trim tabs can improve the ride of your boat by adjusting where the water is hitting the keel line. In a slight chop, the waves may be hitting the keel of your boat around the helm area, causing an uncomfortable ride. By adjusting the trim tabs and lowering the bow, the waves will hit the keel at a more forward point, softening the ride. Experimentation with your trim tabs in various sea conditions will help you determine the best positions for your boat under different load conditions.

Trim tabs are also useful in correcting listing from side to side under varying weight conditions. Usually the list can be corrected by pushing the "bow down" button on the higher side. This will tend to lower the bow by pulling the high side to a level position. If you bow is already in a low position, you may correct list by pressing the "bow up" button on the lower side. This will cause the low side to rise and level the boat.

Trim tabs in the extreme "bow down" position will cause the boat to come on plane with minimum bow rise. Unless you are operating at low speeds or with considerable cockpit weight, you will likely want to raise the tabs slightly when underway in order to avoid "plowing" water. With the tabs in the "bow down" position, you will be able to maintain a plane at the least possible RPM's.

When running in a following sea, the best performance is obtained with the tabs in the "bow up" position.

## Boat Operation

### FUELING

Safety during fueling requires common sense and caution. Please study the following procedure carefully, and ask your dealer if there is doubt about any procedure.

1. Check your engine's owners manual to make sure that you only take on the type of fuel specified by the manufacturer. If you operate an outboard, check the type of oil and the oil-to-gas ratio recommended in the engine manual. Oil should be added in the fueling process when mixing with gas in order to insure the correct amount and proper mixture.
2. Close all ports, hatches, windows and engine compartments before fueling in order to prevent gasoline fumes from accumulating.
3. Stop all engines, motors, fans (including bilge pump) and turn off lights before fueling.
4. Extinguish all cigarettes and other lighted materials.
5. Observe fuel flow constantly to prevent overflow or spillage.
6. After fueling, wash down and clean off any spilled fuel. Dispose of any rags, sponges, etc., used for clean-up on shore. Do not carry these rags on board.
7. Avoid an empty fuel tank, even during storage, as condensation can develop and result in water in your fuel system.
8. In stern drive boats, turn the bilge blower on and run at least 4 minutes before starting engines. Checking for gas fumes in the engine compartment before starting and continue to run the blower until they are eliminated.
9. After securing the fuel cap, open all ports, windows, hatches and engine compartments. Ventilate all other closed areas.
10. Look to see if gasoline was spilled into the bilge during fueling.
11. Dual fuel tank installations are equipped with a manual switching valve for tank selection. Select the tank which will improve the weight distribution as the fuel is consumed. Performance will be affected by the type of engine and weight distribution.



12. The fuel tank compartment is sealed with a removable compartment drain located to the starboard side of the keel line drain tube. This plug should be removed periodically to drain any water accumulation in this area.



### Fuel Maintenance Tips

If you are experiencing fuel flow problems, a quick method of checking if the problem is in your fuel system is to connect a 6-gallon portable tank to your engine.

Your fuel tank is equipped with a removable fuel filter screen and an anti-siphon valve (see diagram for location) which should both be checked if you are experiencing problems.

Have your dealer inspect your fuel system at least once a year including all components hidden from view. Replace all deteriorated hoses and corroded clamps, connections and fittings.

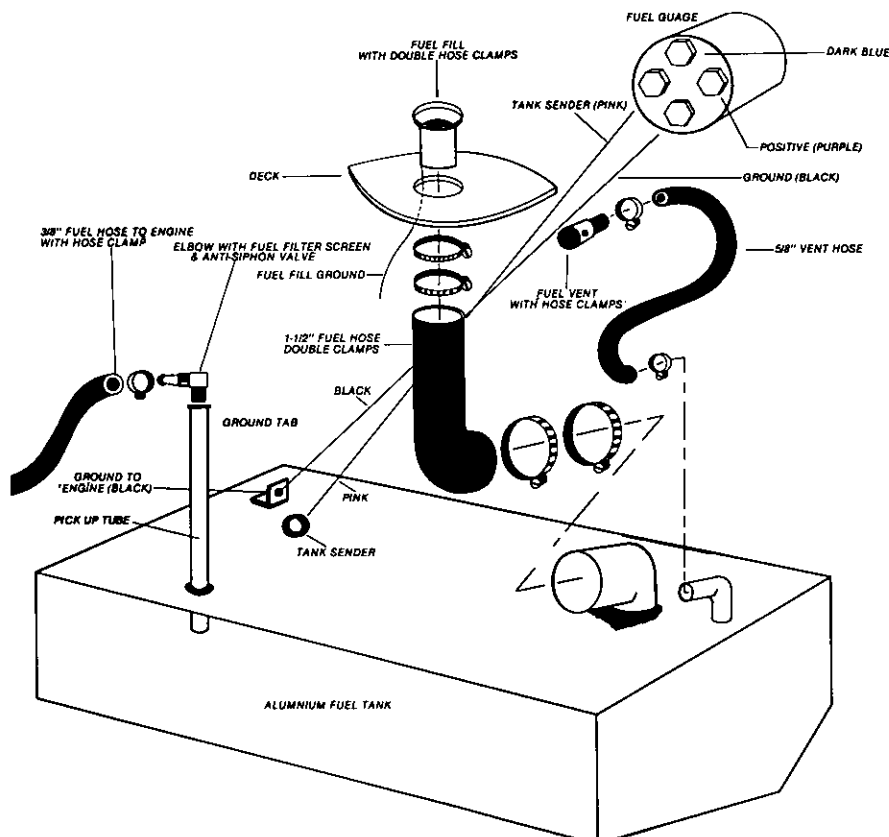

## Propeller

The condition of your propeller has a major influence on your boat's performance. Your engine is equipped with the best size propeller for normal conditions. If you have unusual uses or weight conditions, you may require different propellers for different applications. It is advisable to keep an extra propeller on board. A damaged propeller can effect your boat's top speed, cause vibrations or a sudden drop in RPM's, or increase your fuel consumption.

**CAUTION:** When replacing propellers, make sure you stay within the engine manufacturer's maximum and minimum RPM ranges. This information is in your engine owner's manual. If your boat does not have a tachometer, consult your dealer for propeller changes.

Cavitation occurs in all propeller driven boats under certain conditions. It is easily recognized by sudden increases in RPM's (revving) or a sudden drop in speed. This occurs when cavities, or air pockets, form around the propeller. Cavitation is influenced by propeller design, speed, placement and even water temperature. In most cases, a change in the drive angle (trim) will correct the problem. If the problem persists, contact your dealer for assistance.

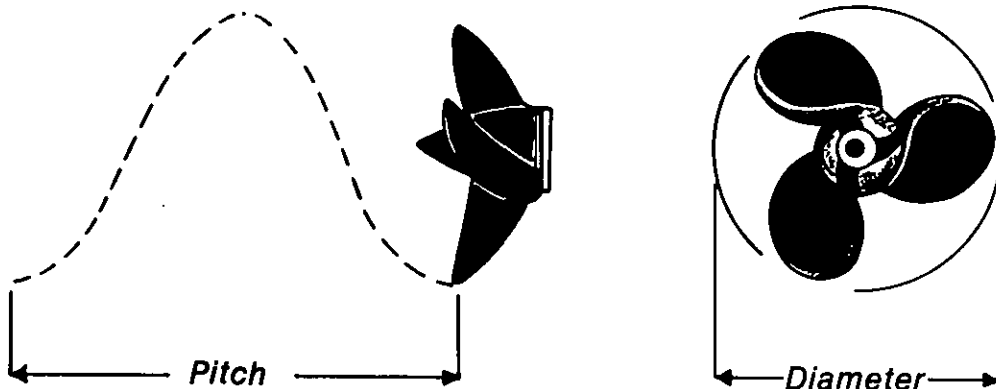

## Trailer

The adjustment and balance of your boat on your trailer largely determines the trailerability of your boat. Swaying while trailering is usually caused by a tail-heavy load. A rule of thumb is that the tongue weight on the hitch ball should be about 3% of the total weight of your boat, motor and trailer. The rollers and/or bunkers of your trailer should be adjusted so that the weight is distributed evenly across the stern and forward throughout the keel section. Your dealer should be responsible for adjusting your trailer properly.

Check the following prior to trailering your boat:

1. Hitch tight and secure.
2. All nuts and bolts securely tightened and the safety chain properly secured.
3. Winchlocks and tilt mechanism in correct positions.
4. Tires properly inflated and in good condition (including spare).
5. Signal, stop and other lights operating properly.
6. Gear on boat properly secured for travel.
7. Tie down straps are secure.
8. Wheel bearings properly greased (each year).
9. All cabin windows and doors secured.
10. All canvas tops, side curtains are taken down and secured to prevent wind damage/loss in transit.
11. All lines are properly secured.
12. Mooring cover removed. (Damage to canvas during transit is not covered in warranty).

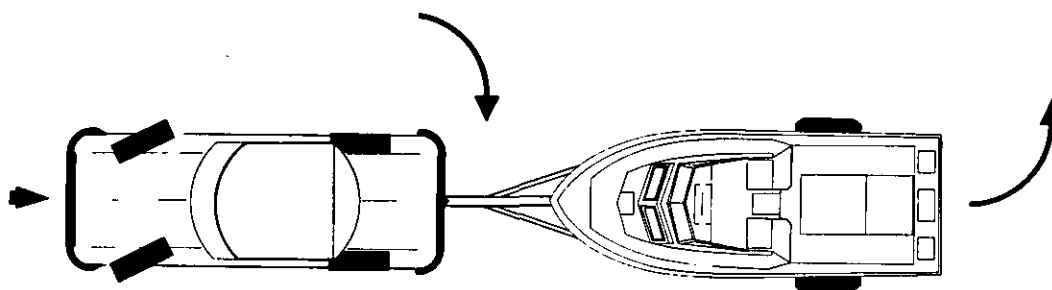

*Backing to right*

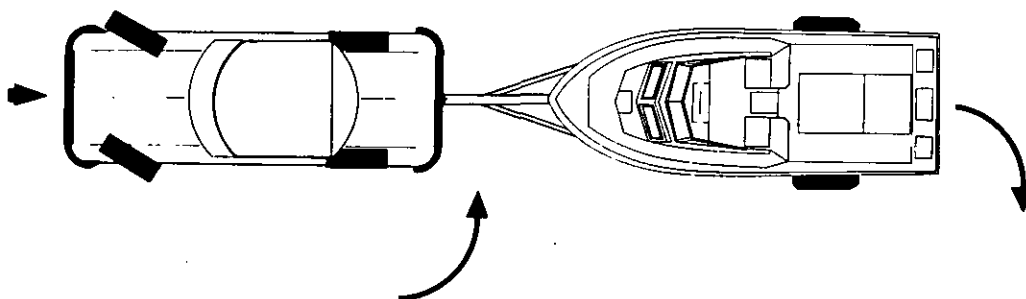

*Backing to left*

## Pre-Launch Check List

Prior to initial launch, familiarize yourself with all aspects of your boat included in this manual. At the launch, go through a pre-launch check list. The check list should be suited to your particular needs but the following items should be included:

1. Make sure drain plug is in place.
2. Have a launch rope attached.
3. Have the proper safety equipment on board.
4. Check the capacity plate and do not exceed capacity ratings.
5. Tilt engine or drive unit to "up" position.
6. Remove tie down strap.
7. Make sure engine drain plug and freeze plugs are closed.

After the pre-launch check, back your trailer slowly into the water preferably keeping the axle hubs above water (unless your trailer is a submersible model). Set the hand brake of your car and place chocks under the rear wheels if chocks are available. Attach a bow line securely to the boat, release the winch cable and give the boat a firm push to roll it off the trailer.

After the boat is clear of the trailer and secured to the dock, move the trailer to the parking area.

## Pre-Start Check List

Before starting your engine, check the following:

1. Check the bilge for excess water and leaks.
2. Turn on the bilge pump to remove any excess water, leave the pump on stand-by.
3. On stern drives, turn on the bilge blower and check for leaking fuel or fumes. Run the blower for at least 4 minutes prior to starting.
4. Check engine oil level, battery cable connections, electrolyte level, and all drive belts for proper wear and tension. Check steering for freedom of movement and tightness. Check navigation lights.

## Starting

1. Lower the drive unit to the "down" position. Be sure the propeller is free of any obstruction.
2. Set the control lever in the neutral position. Engage the neutral lock out button in the control handle and pump the control throttle forward 2 or 3 times. Set control throttle slightly forward of straight up and turn the ignition key to start. Adjust the throttle to 1200 RPM's and check instruments. If the oil pressure gauge does not respond immediately, shut off engine. If the oil pressure is normal, check the engine area again for fumes or leakage. Test steering response and throttle response at the dock.



## Performance

Keep your hull clean for maximum performance. Detailed recommendations for hull cleaning are included in the MAINTENANCE section.

Stern drive models and many outboard models are equipped with power tilt and trim mechanisms. The purpose of the tilt is to raise the engine for launching, loading or trailering your boat.

Trim refers both to the weight distributions inside the boat and to the angle of thrust of the drive unit. The proper weight distributions of passengers and gear can affect performance. The angle of thrust of the drive unit either forces the bow up or down. A drive unit trimmed too far in (forward) will cause the bow to nose downward or "plow". A drive unit trimmed too far out (aft) will cause the bow to ride too high. Adjust the trim so that the angle of thrust is parallel to the water at full throttle at a normal running attitude.

When the angle of thrust is too far out (aft), the engine noise may rise indicating that the propeller is cavitating. Trim the engine in (forward) to correct the problem. The boat may also tend to "porpoise" in maximum bow up position as well. This can be corrected by trimming the bow down by adjusting the engine in.

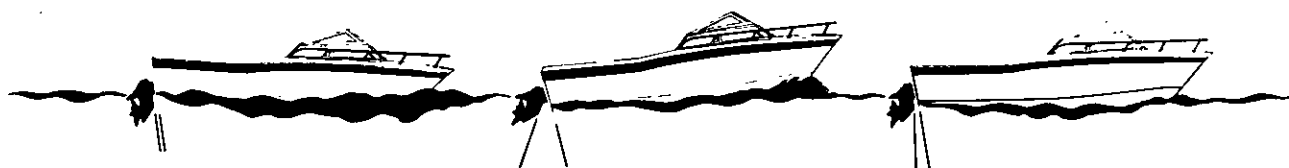

**INCORRECT**  
Causes boat  
to "plow"

**INCORRECT**  
Causes boat  
to "squat"

**CORRECT**  
Gives maximum  
performance

When running into heavy seas, the bow should be adjusted so that the entry point into the water is slightly forward of the helm location for a smoother ride. When running in a following sea, the bow should be trimmed up higher to prevent the boat from plowing into the seas.

As sea conditions change, experiment with the trim to find the best performance for your particular boat and load.

\*\*\*\*\*

### Very Important!

Most drive units are equipped with an adjustable rudder trim tab. This trim tab should be adjusted to balance the steering at the speed which you most often travel. Variations in speed or boat load or changes in the drive unit trim will cause the steering to pull in one direction. If the boat pulls to the left, adjust the trim tab to the left and vice versa.

\*\*\*\*\*

## Anchoring

The size of your boat and the type of lake, sea or river bottom in your boating area should determine the size and type of anchor. The recommended anchor line length is 4 to 7 times the depth of the water. In strong winds and currents, this length should be increased.

A 3 to 4 foot length of chain between the anchor and the anchor line will help prevent the line from chaffing on rough obstacles below the surface and will also help hold anchor arm down for more secure anchoring.

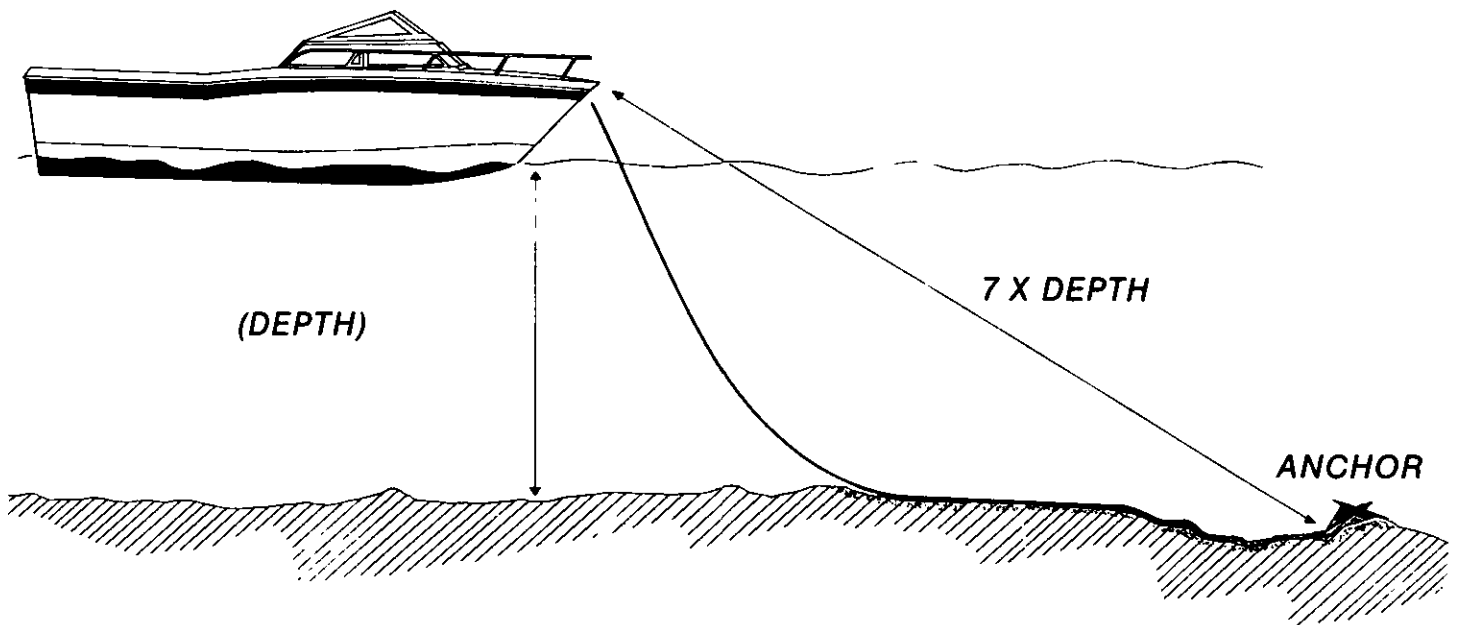

To anchor, head the boat into the wind or current, stopping forward motion. Make sure your anchor line is secured to a cleat and travels under the bow rail. Lower the anchor into the water until it reaches bottom. Feed out anchor line slowly as the wind or current forces the boat backward. If necessary reverse your engine. Before shutting down engines, make sure the anchor is secure.

To raise anchor, reverse the procedure by driving the boat slowly to the point directly above the anchor and pull straight up. If the anchor is difficult to raise, you may tie off the anchor line when directly over the anchor and slowly motor forward to "free" the anchor from the bottom.

Your boat will swing at anchor with the wind, so do not anchor close to other boats or objects. Also, remember that it is illegal to tie up to navigational aids such as bouys and markers.

**WARNING:** Never anchor off the stern of the boat, especially in strong winds or currents. The weight of the stern and flat surface to the seas can easily cause water to enter over the transom, swamping the boat.



## Docking

Unlike an automobile, the stern of your boat reacts first when turning. A turn to the right will swing the stern to the left and vice versa. Remember that turning your boat away from an object such as a dock will tend to swing the stern toward that object. Before bringing your boat to the dock, consider the wind and how it may be used to your advantage. Approach the dock at a 30 to 45 degree angle at a slow speed. Before the bow reaches the dock, shift the engine to neutral, turn the steering wheel toward the dock and shift the engine into reverse. The boat will slow and the stern will swing toward the dock.

When pulling away from the dock, make sure you have enough room to maneuver before turning by pushing the stern clear. You can then ease away without bumping the stern against the dock.

Slowing and stopping your boat requires some practice. As you slow the throttle, the boat will slow down. The length of time to come to a complete stop will vary with wind and current. In addition, the judgement of distance and momentum on the water is a skill that improves greatly with practice.

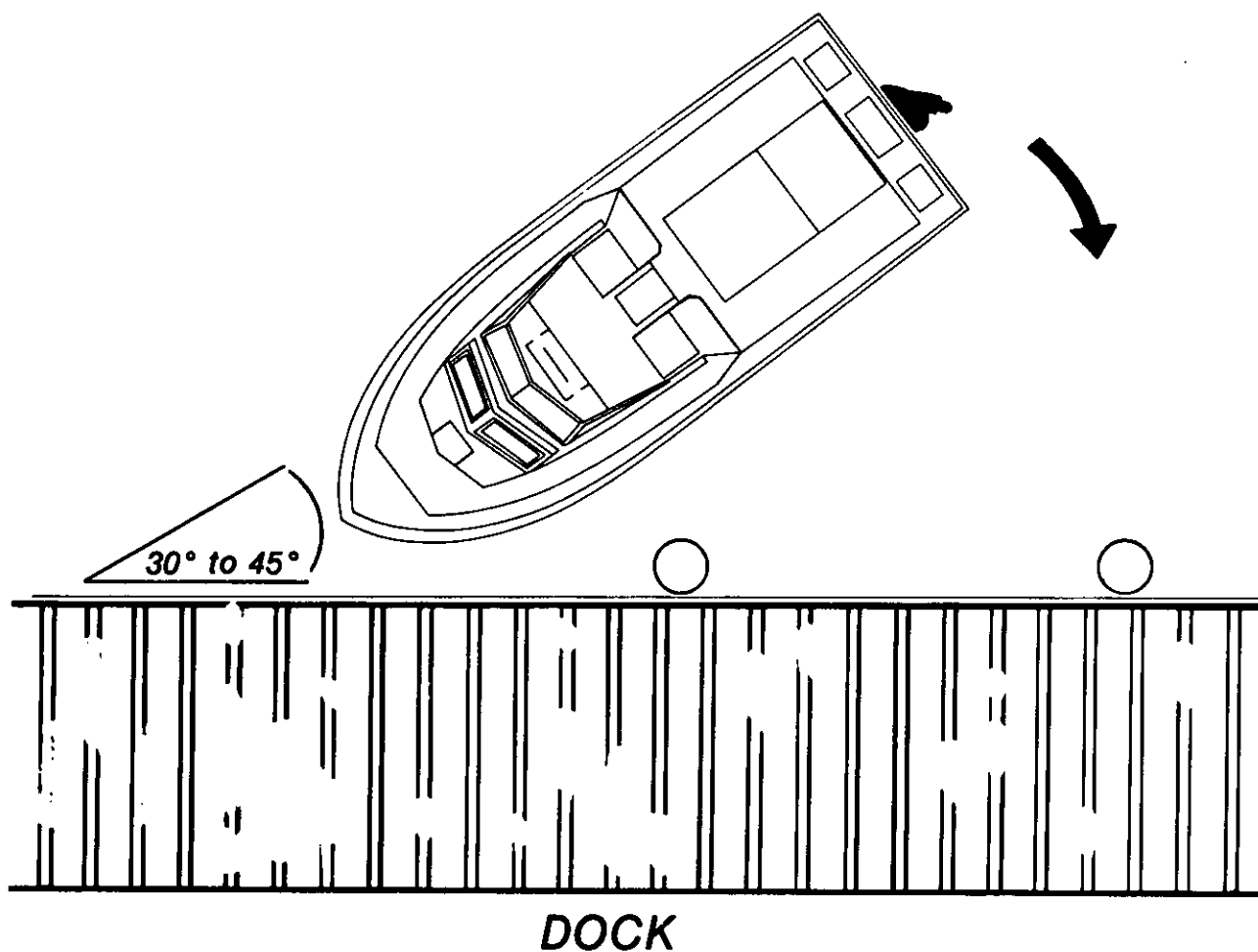

## Maintenance and Service

Proper maintenance of your boat is not only a source of pride but is the key to maintaining your boat's value. A few simple steps will keep your fiberglass Grady-White looking showroom bright for years.

Your hull and deck are constructed by the hand lay-up method using the highest quality gelcoat, fiberglass mat and woven roving. This method of construction insures a proper fiberglass-to-resin ratio and a uniform thickness which together result in a much stronger boat than those constructed of "chopped glass". This is an expensive process, but it insures that your Grady-White is the strongest, most durable fiberglass boat possible.

### Fiberglass Finish

The outer skin, or gel coat, of your Grady-White is a thin layer of resin with the finished color pigment. It is an integral part of the hull laminate. This tough, durable outer layer makes routine maintenance relatively simple.

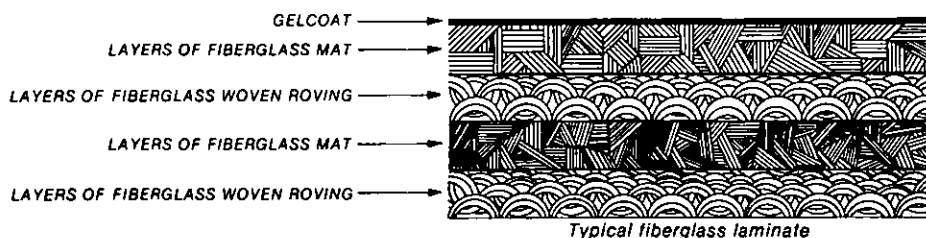
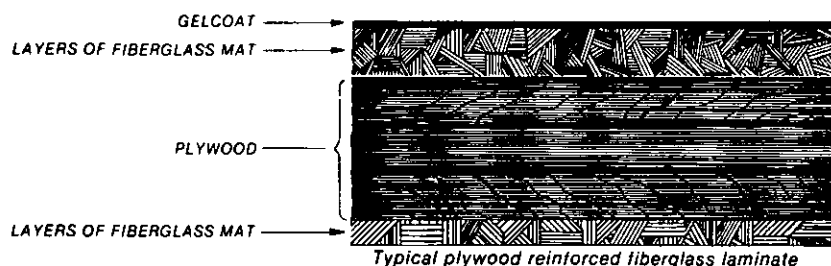

The gelcoat of your Grady-White is the finest available. The best method of routine upkeep, is almost like maintaining the finish of an automobile. The best method of cleaning the boat is with a mild household detergent and plenty of fresh water. A good coat of wax (either automobile or boat wax will do) will maintain the smooth, glossy finish and protect the boat's surface. Do not wax surfaces that may be walked on, however, as they will become quite slippery when wet.

Though gelcoat is a very durable material, it can still be subject to small spider web-like cracks (crazing), scratches and blistering over years of use. It is elastic enough, however, to withstand strong blows while flexing with the hull's movement. Gelcoat problems are cosmetic and will not effect the structural integrity of your boat.

If you store your boat in the water for more than a few days at a time, the bottom of the boat below the waterline should be painted with anti-fouling paint to protect it from marine growth, barnacles and blistering which inhibit performance.

Any anti-fouling paint with a chemical toxic base and not containing copper or mercury works well on fiberglass. Anti-fouling paint slowly dissolves to prevent marine growth so inspection and cleaning of the boat bottom at least once per season is advisable. Repaint when necessary.

## Gelcoat Repair

Many gelcoat imperfections can be repaired using the following procedure:

1. Obtain the original colored gelcoat from your dealer and a small amount of M.E.K. (catalyst) which when mixed with the gelcoat, will cause it to harden. You may also wish to obtain a little acetone which is the most suitable cleaning agent for gelcoat.

**WARNING!** M.E.K. (Methyl ethyl ketone peroxide), gelcoat and acetone are flammable and hazardous if not handled properly. Follow instructions on the containers carefully. After gelcoat is catalyzed, it may become hot in the mixing container and catch on fire. Submerge remaining gelcoat in water until cool before disposal.

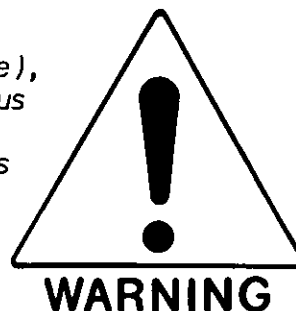

2. If the surface to be repaired is flat, lightly sand this surface (removing all glossy areas) so that the new gelcoat will adhere to the surface. If the area to be repaired is cracked, the crack should be routed out with a small instrument. Any crack extending past the gelcoat surface and into the fiberglass would need a more extensive repair. We suggest you consult your dealer for additional instructions. Tape off all adjacent areas around the damaged area.

3. A small amount of gelcoat should be tested with the catalyst before mixing the material for your repair. You will then be able to understand how the chemicals react. Pour approximately 1/2" of gelcoat into a small cup and add approximately 1.5% M.E.K. (about 3 to 5 drops) and stir thoroughly. If mixture appears too thin for repair, add a small amount of talcum powder. Spread a small amount of the mixture on a test surface and measure the time it takes to harden. Hardening time should be from 15 to 45 minutes. Too little M.E.K. will lengthen the hardening time. Too much M.E.K. will cause the patch to become rubbery and it will not cure properly. It is best to be under catalyzed. When you obtain the proper mixture in a test, you are ready to mix a new batch for the actual repair, using the same ratio of M.E.K. to gelcoat.

4. Apply to the defective area using a small stick (a medical tongue depressor or popsicle stick works well). The mixture should be applied in a thin layer, bringing the patch up to the level of the original surface. Too much material will require extra sanding.

5. When the patch is hard, any raised area should be sanded carefully with 220 grit sandpaper bringing it near level with the original surface. Use 400 or 600 grit sandpaper which has been wettened with water as you approach the finished surface. The water will reduce scratching. Wrapping the sandpaper around a small block of wood will help keep the area being sanded level.

6. Remove the tape around the patch and sand with 600 grit until patch is level with original surface. You will notice that the repaired area has a dull finish. Any good automotive buffing compound applied with a power buffer will bring a lustre to the surface.

## Interior Maintenance

Your interior vinyl upholstery may be cleaned with a mild solution of household detergent and fresh water. Also, commercially available cleaners for vinyl work well. Just follow the instructions.

As the seams of your upholstery are not water proof, your upholstery should be stored in the cabin or covered when not in use.

Lounge seat bases, which are constructed of marine plywood, should be partially spread for ventilation when the boat is not being used.

Some Grady-Whites have an indoor-outdoor type carpeting. This carpeting should be cleaned in the same manner as vinyl. A simple washing will often accomplish the job.

Some cabin cushions are of a Herculon-type fabric and may be cleaned with upholstery cleaner. Most cabin cushions are removable and may be dry cleaned. Do not machine-wash these fabrics.

## Canvas

Follow these steps to maintain your boat's top and other canvas:

1. Dry all canvas before storing to prevent mildew.
2. Wash canvas periodically with a heavy-duty detergent and warm water. Do not use petroleum-based cleaners on canvas or clear vinyl as they will cause the vinyls to yellow
3. Frequently lubricate the snap buttons and zippers with petroleum jelly or paraffin and they will be much easier to operate efficiently.
4. Clean clear vinyl thoroughly with denatured alcohol then apply a protective layer of clear wax. This process should be repeated as necessary to maintain the protective wax coating.
5. Never trailer your boat with the canvas up. All canvas should be stored and secured before trailering.

Though your Grady-White boat's canvas is made using the highest quality vinyl and latest sewing techniques, your boat is basically an "open" vessel and your boat's canvas will not be completely leak proof. The seam holes in your canvas may stretch and tend to leak water. However, you can correct much of this problem by rubbing paraffin over the seams.

Please understand that Grady-White does not warrant the fit and design of the canvas to be completely watertight.

## Teak

Teak is used in Grady-Whites because of its beauty and low maintenance. Richly supplied with natural oils, teak weathers well. But, after repeated exposure, the teak may turn gray. It should be cleaned with detergent or commercial teak cleaner and then oiled to return it to its natural color.

## Hardware

Wash your hardware after every use and in between uses with a mild detergent and water. Quality chrome polish should also be applied. Periodically clean all hinges, such as the baitwell hinges. When these hinges are dry, lubricate them with a penetrating oil to insure that they swing freely. Your bow rail is a high quality stainless steel, but it will show signs of rusting if it is not cleaned frequently.

## Hardware mounting

When drilling mounting holes in boat surfaces, be sure each hole is well sealed. Sealing will prevent water leakage, which is especially important in fiberglass areas that have been reinforced with plywood. Improperly sealed holes risk trapping water inside plywood reinforced areas which can cause the wood to deteriorate.

## Battery

No matter what type of power your boat uses, your battery(ies) are extremely important. They should be secured in position in a non-metallic tray to prevent spilling electrolyte. Make sure the battery is properly secured for running.

Check the fluid level in each battery cell at least once a month. Fill the battery with distilled water to the upper level as shown in the illustration. Never overflow the battery.

Keep terminals clean by scrubbing with a mixture of baking soda and water, using a stiff brush. Then apply a light coat of grease. Do not let any of the baking soda/water mixture enter the battery.

Check the battery every month when not in use by using a battery hydrometer which measures the specific gravity. The meter should read between 1250 and 1280.

Never disconnect the battery when the engine is running as damage to the charging system could result.

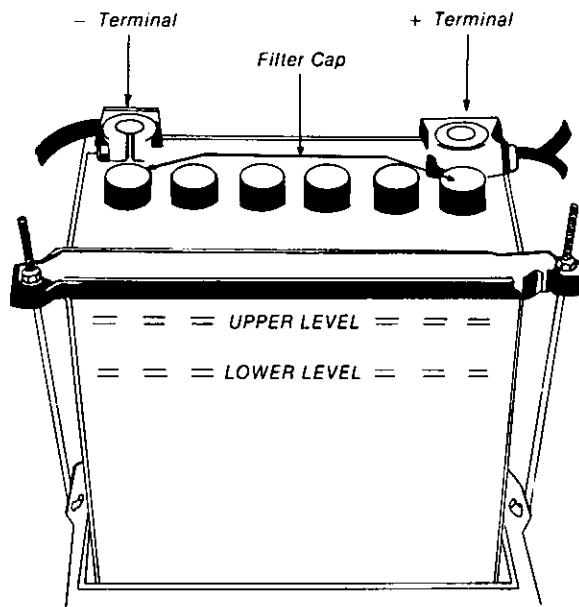

The battery contains sulfuric acid. Avoid contact with skin, eyes or clothing. Antidote: EXTERNAL — Flush with water. INTERNAL — Drink large quantities of water or milk. Follow with milk of magnesia, beaten egg or vegetable oil. Call physician immediately. Eyes: Flush with water and get prompt medical attention. Batteries produce explosive gases. Keep sparks, flame, cigarettes away. Ventilate when charging or using in enclosed space. Always shield eyes when working near batteries.

**KEEP OUT OF REACH OF CHILDREN.**

\*\*\*\*\*  
Remember when disconnecting and reconnecting battery cables that the black cable must be connected to the negative terminal and that the red cable must be connected to the positive terminal of the battery. Reversing this procedure will immediately damage your system.  
\*\*\*\*\*

## Scuppers

Most Grady-White boats have self-bailing cockpits, meaning that water on the cockpit floor drains through overboard drains rather than into the bilge. The stern drains (scuppers) have an external scupper flap assembly (as shown below) which restricts the flow of water back into the boat through the scupper system. Inspect the flaps periodically to make sure that they are free of debris. The scupper flaps will need periodic replacement.



## Engine

If your Grady-White is powered by a stern drive or Sea Drive engine, refer to the engine manufacturer's manual for proper maintenance procedures. Complete the engine warranty card at the time of purchase and forward it to the manufacturer.

If your boat is outboard-powered, your dealer should provide an outboard owner's manual to help you with routine maintenance.

## Storage

If your boat is out of use for the winter special attention should be paid to areas that may be damaged by freezing temperatures. Even if you live in a warm climate, you should inspect your boat on an annual basis.

Use the following check list for winter storage:

1. There are detailed instructions in your engine's owners manual regarding the procedures to be followed in winterizing the engine. Follow these important instructions carefully and your engine will survive the most severe weather conditions.
2. Clean and wax your boat before storage. If you have stored your boat in the water, there may be a layer of growth on the bottom in addition to the anti-fouling paint. This debris will harden on the boat bottom as it dries so scrub the bottom immediately after the boat is removed from the water.
3. If you are storing your boat on a trailer or cradle, make sure that they fully support the keel, chines and under the transom.
4. Raise and block the trailer axle to prevent tire deterioration. This is an excellent time to lubricate and pack the wheel bearings per manufacturers' instructions.
5. Remove the bilge drain plug, and open all valves and seacocks to keep the bilge dry. Drain all tanks, water lines and pumps to prevent freeze damage. In warmer climates, draining will help prevent water stagnation. Store your boat with the bow elevated to help drainage.



## Accessory Wiring Color Code and Fuse Sizes

| ACCESSORY                       | WIRE SIZE & COLOR               | FUSE<br>AMPS |
|---------------------------------|---------------------------------|--------------|
| Bow Light                       | 16 Ga. Gray                     | 15.0         |
| Aft Pole Light                  | 16 Ga. Gray/White Stripe        | 15.0         |
| Mast Light (forward bulb)       | 16 Ga. Gray/Red Stripe          | 15.0         |
| Mast Light (aft bulb)           | 16 Ga. Gray/Black Stripe        | 15.0         |
| Panel Lights                    | 16 Ga. Dark Blue                | 15.0         |
| Cabin Lights                    | 16 Ga. Dark Blue                | 10.0         |
| Courtesy Light                  | 16 Ga. Dark Blue                | 10.0         |
| Interior Lights                 | 16 Ga. Dark Blue                | 10.0         |
| <br>                            |                                 |              |
| Bilge Pump (Forward):           |                                 |              |
| Rule 800                        | 16 Ga. Brown/Black Stripe       | 4.0          |
| Rule 1500                       | 16 Ga. Brown/Black Stripe       | 7.5          |
| Auto Float Switch (Fwd)         | 16 Ga. Brown/Red Stripe         |              |
| <br>                            |                                 |              |
| Bilge Pump (Aft):               |                                 |              |
| Rule 800                        | 16 Ga. Brown                    | 4.0          |
| Rule 1500                       | 16 Ga. Brown                    | 7.5          |
| Auto Float Switch (Aft)         | 16 Ga. Brown/White Stripe       |              |
| <br>                            |                                 |              |
| Aerator Pump                    | 16 Ga. Orange/(2) Brown Stripes | 2.0          |
| Shower Sump Pump (float switch) | 16 Ga. Brown/Orange Stripe      | 4.0          |
| Water Pressure Pump (Shower)    | 10 Ga. Red                      | 20.0         |
| Water Pressure Pump (25 Trophy) | 16 Ga. Orange                   | 2.5          |
| Washdown & Livewell pump        | 16 Ga. Orange/Brown Stripe      | 7.5          |
| Bilge Blower                    | 16 Ga. Yellow                   | 10.0         |
| Horn                            | 16 Ga. Orange/White Stripe      | 5.0          |
| Windshield Wiper (actuator)     | 16 Ga. Orange/Black Stripe      | 5.0          |
| Windshield Wiper (position)     | 16 Ga. Orange                   |              |
| Accessory                       | 16 Ga. Orange                   | 10.0         |
| Cigarette Lighter               | 16 Ga. Orange/Red Stripe        | 10.0         |
| Stereo                          | 16 Ga. Green/White Stripe       | 5.0          |
| Accessory Grounds (Ind)         | 16 Ga. Black                    | N/A          |
| Accessory Grounds Mains         | 10 Ga. Black                    | N/A          |
| Hydraulic Trim Tabs             | 16 Ga. Harness (Supplied)       | 20.0         |
| Main Fuel Tank (Sender)         | 16 Ga. Pink                     | 2.0          |
| Aux Fuel Tank (Sender)          | 16 Ga. Pink/White Stripe        | 2.0          |
| Port Junction Box               | 10 Ga. Orange                   | 30.0         |
| Accessory Panel Power Lead      | 10 Ga. Red                      | in line 20.0 |
| Ignition Switch Power Lead      | 10 Ga./16 Ga. Red               | in line 20.0 |
| Electric Primer Pump            | 16 Ga. Pink/Red Stripe          | in line 5.0  |
| Tilt (OMC Stern Drive)          | 16 Ga. Purple                   | 6.0          |
| Selectrim (OMC Sea Drive)       | 16 Ga. Purple                   | 6.0          |
| VHF (Hardtop Radio Box)         | 10 Ga. Red                      | in line 20.0 |

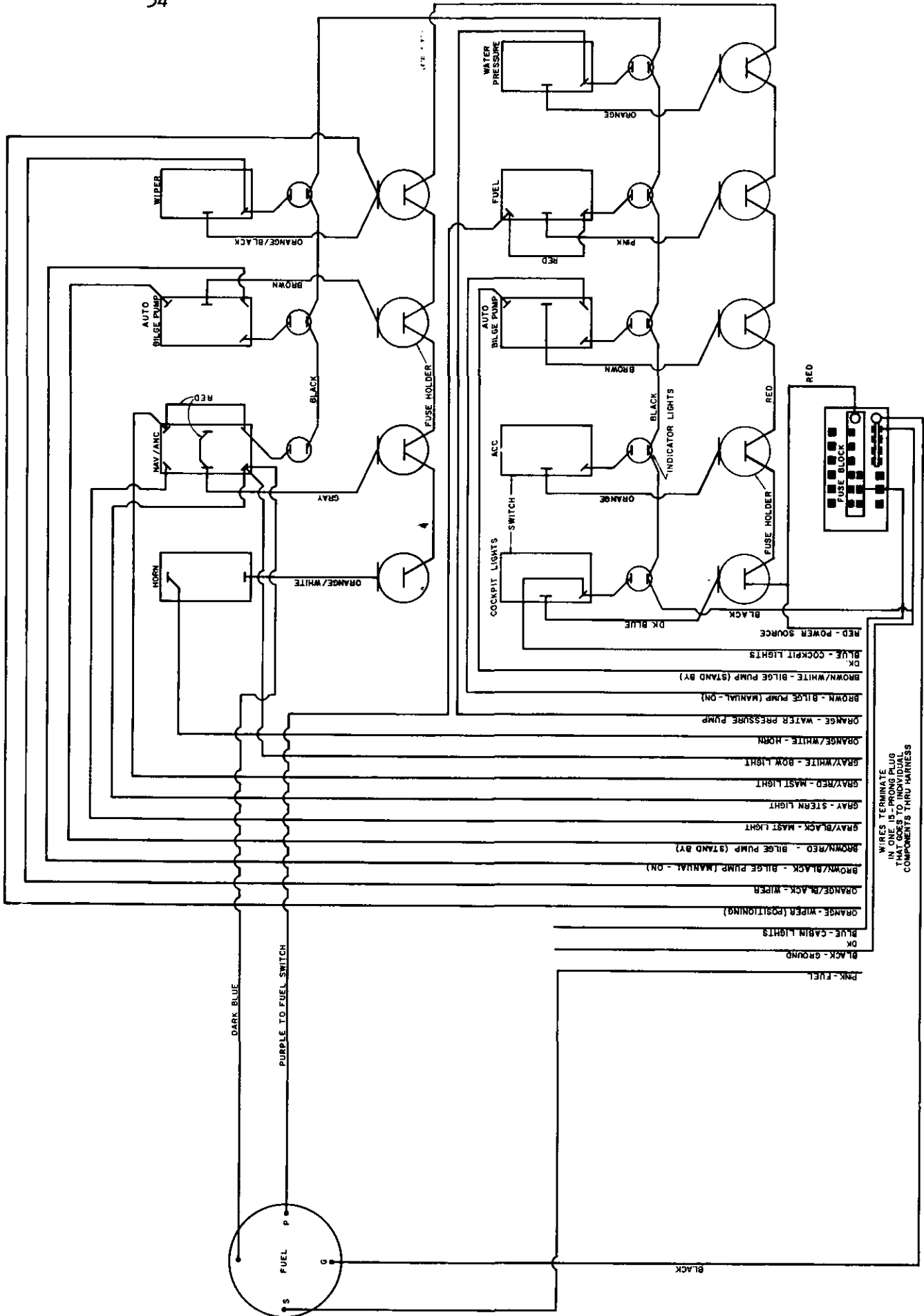

Typical Outboard Instrument and Switch Panel Wiring Diagram

- NOTE:
1. ALL COMPONENT SWITCHES ARE NOT INSTALLED ON SOME MODELS. DRAWING APPLIES TO ONLY THOSE ITEMS THAT ARE INSTALLED AND CONNECTED. EXTRA WIRES ARE IN HARNESS FOR DEALER TO INSTALL OTHER LABELED SWITCHES AND ACCESSORIES.
  2. FUEL 2-WAY SWITCH ILLUSTRATED FOR BOAT WITH 1 TANK. BOATS WITH 2 TANKS HAVE 3 POSITION SWITCH AS NOTED IN FIG. 1.
  3. SOME MODELS HAVE ALL ACCESSORY SWITCHES FUSED AT THE FUSE BLOCK.
  4. INDICATOR LIGHTS ARE NOT INSTALLED ON SOME PANELS.

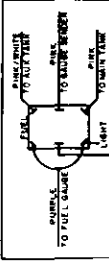

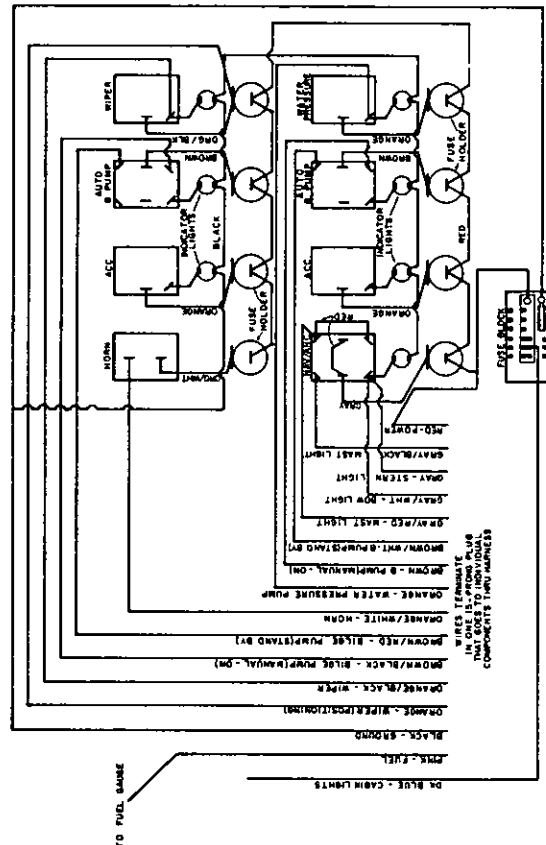
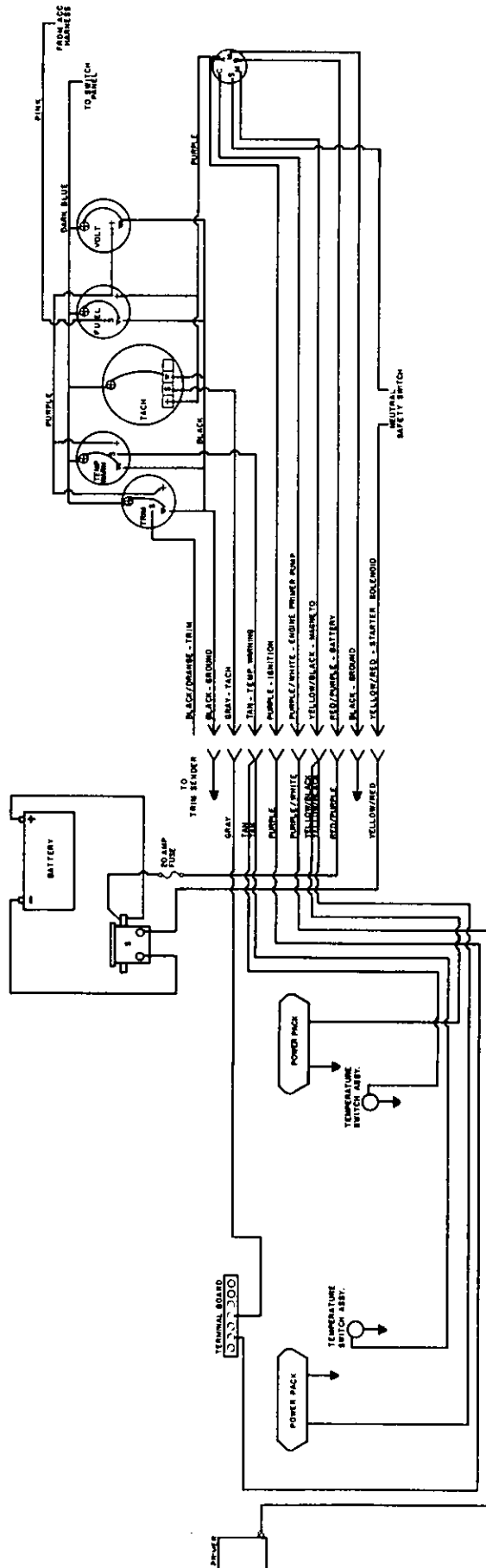

- NOTE:**
1. ALL COMPONENT SWITCHES ARE NOT INSTALLED ON SOME MODELS. DRAWING APPLIES TO ONLY THOSE ITEMS THAT ARE INSTALLED AND CONNECTED. EXTRA WIRES ARE IN HARNESS FOR DEALER TO INSTALL OTHER LABELLED SWITCHES AND ACC.
  2. INDICATOR LIGHTS ARE NOT INSTALLED ON SOME PANELS.
  3. MODELS WITH DUAL FUEL TANKS HAVE A 3-WAY SWITCH AS NOTED IN FIG. 1.

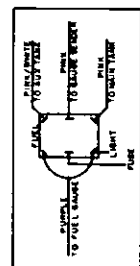

Typical OMC Sea Drive Instrument and Switch Panel Wiring Diagram

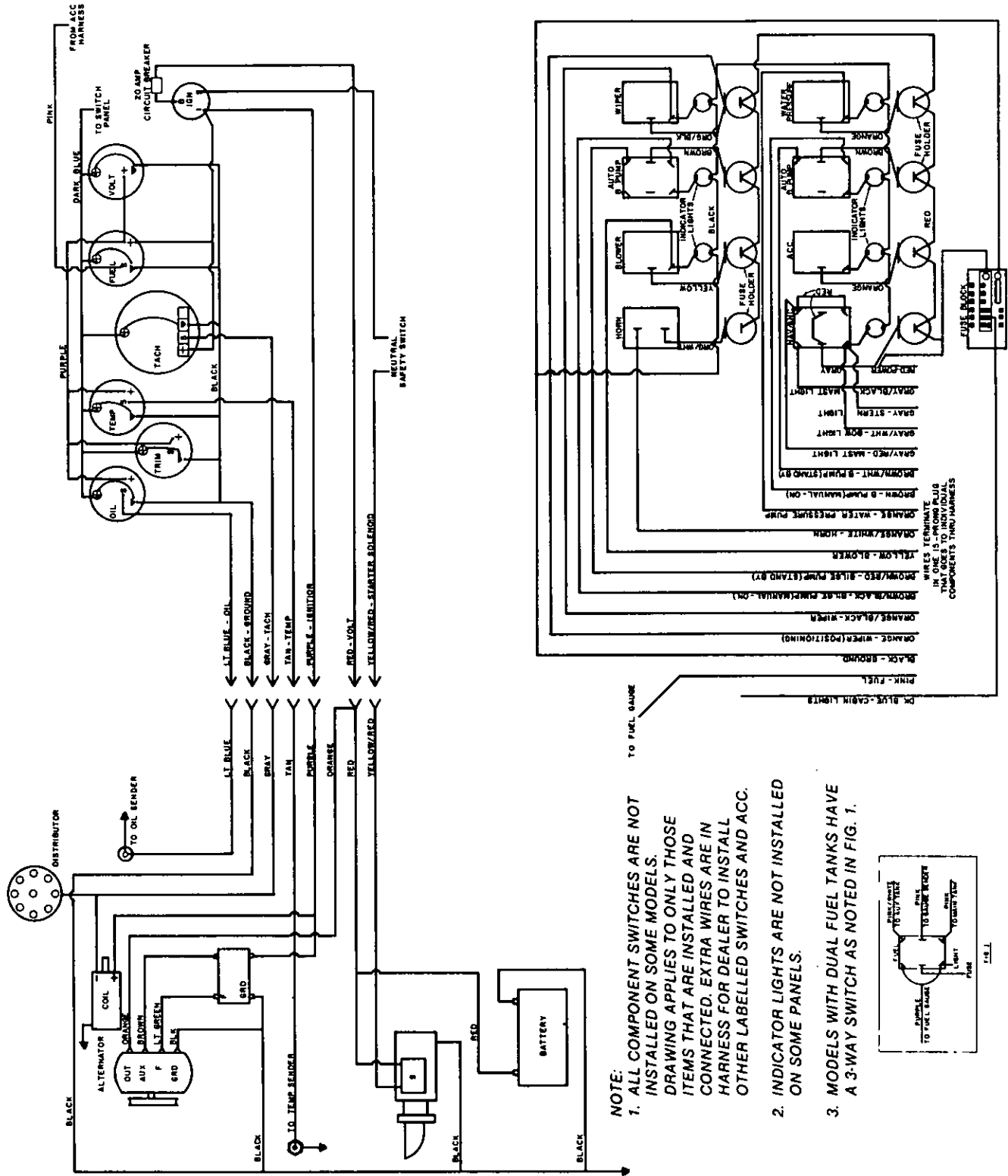

- NOTE:**
1. ALL COMPONENT SWITCHES ARE NOT INSTALLED ON SOME MODELS. DRAWING APPLIES TO ONLY THOSE ITEMS THAT ARE INSTALLED AND CONNECTED. EXTRA WIRES ARE IN HARNESS FOR DEALER TO INSTALL OTHER LABELLED SWITCHES AND ACC.
  2. INDICATOR LIGHTS ARE NOT INSTALLED ON SOME PANELS.
  3. MODELS WITH DUAL FUEL TANKS HAVE A 3-WAY SWITCH AS NOTED IN FIG. 1.

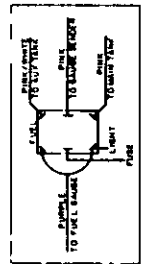

Typical Stern Drive Instrument and Switch Panel Wiring Diagram

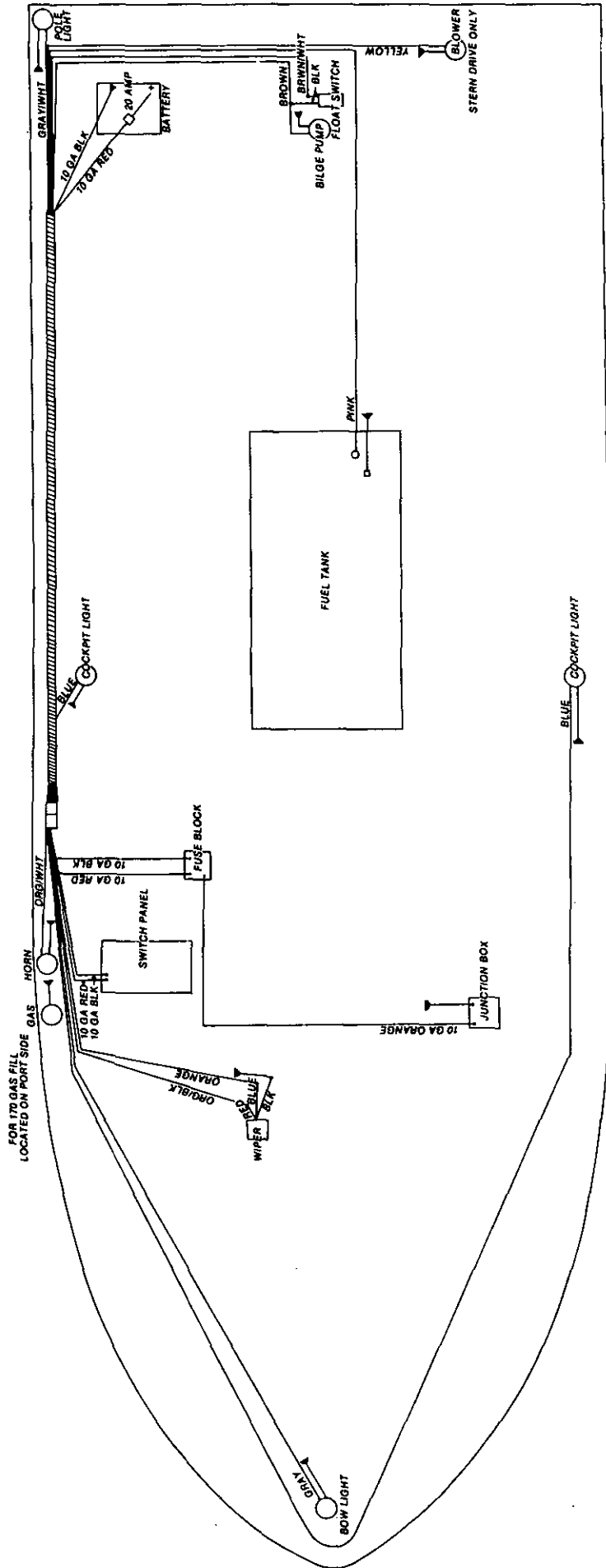

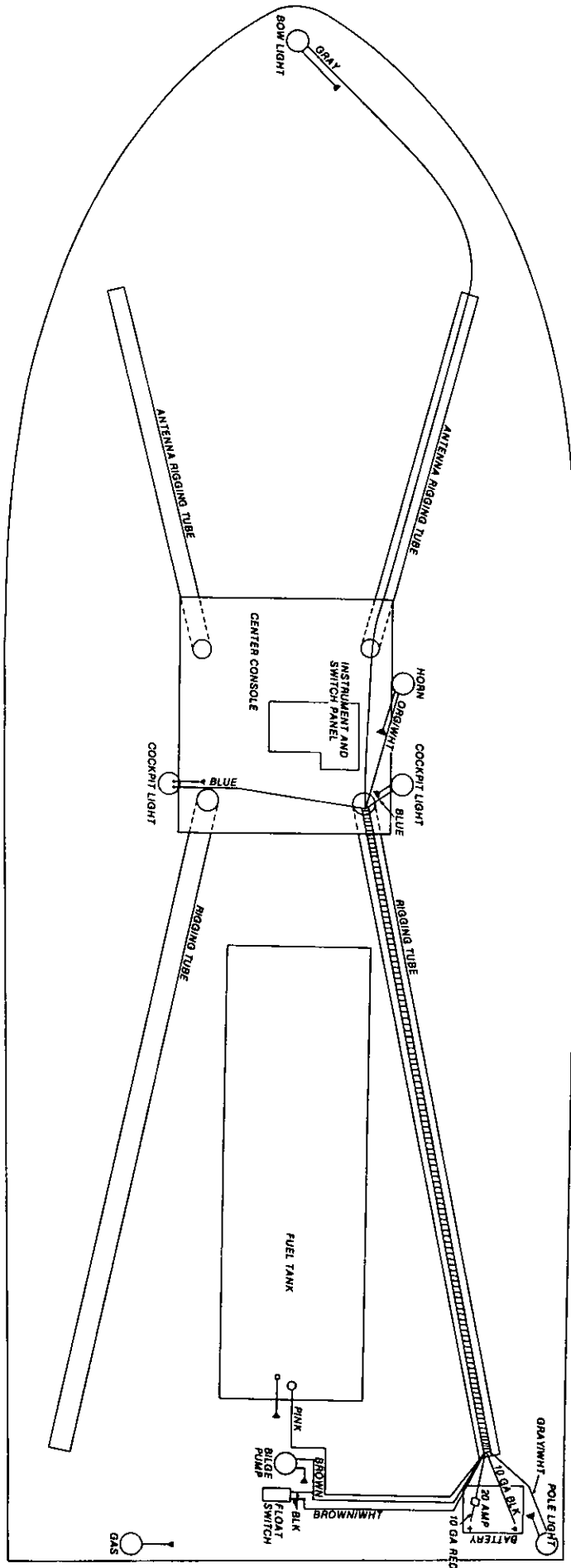

Accessory Wiring Diagram: 204 Fisherman

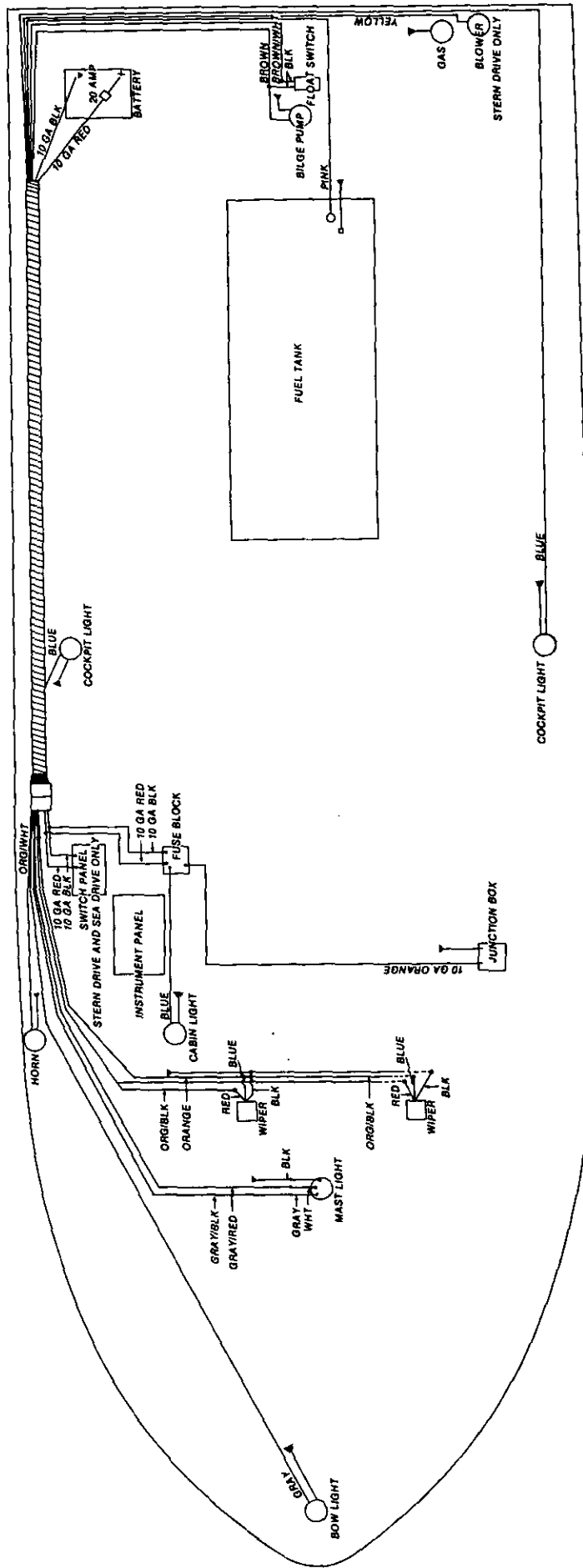

Accessory Wiring Diagram: 20' Overnighter Series

Accessory Wiring Diagram: 22' - 24' Tournament Series

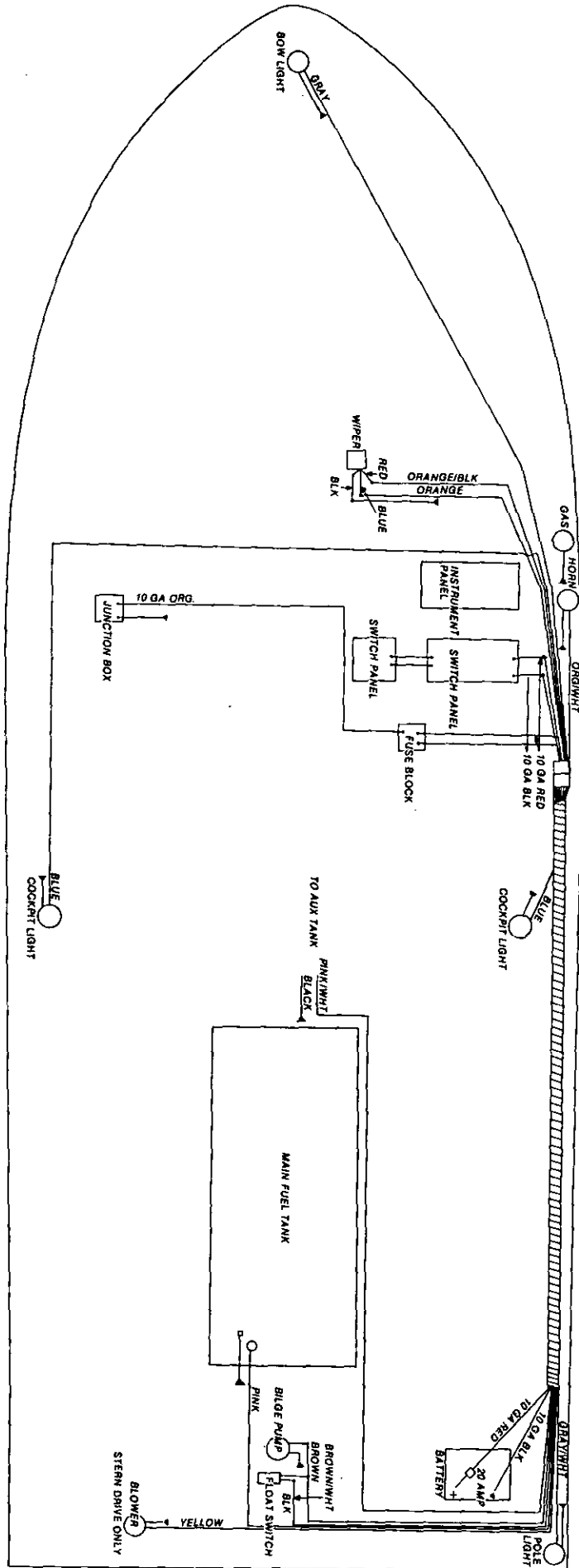



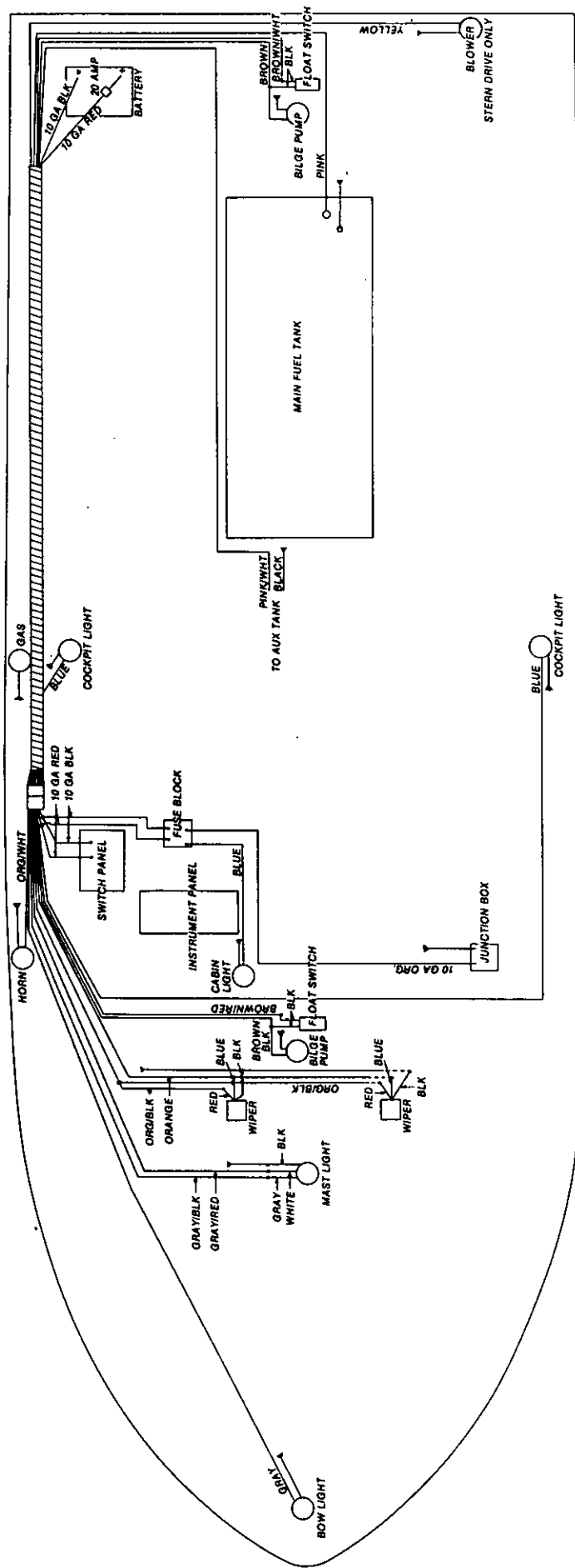

Accessory Wiring Diagram: 22' Seafarer Series and 24' Offshore Series

Accessory Wiring Diagram: 25' Sailfish Series

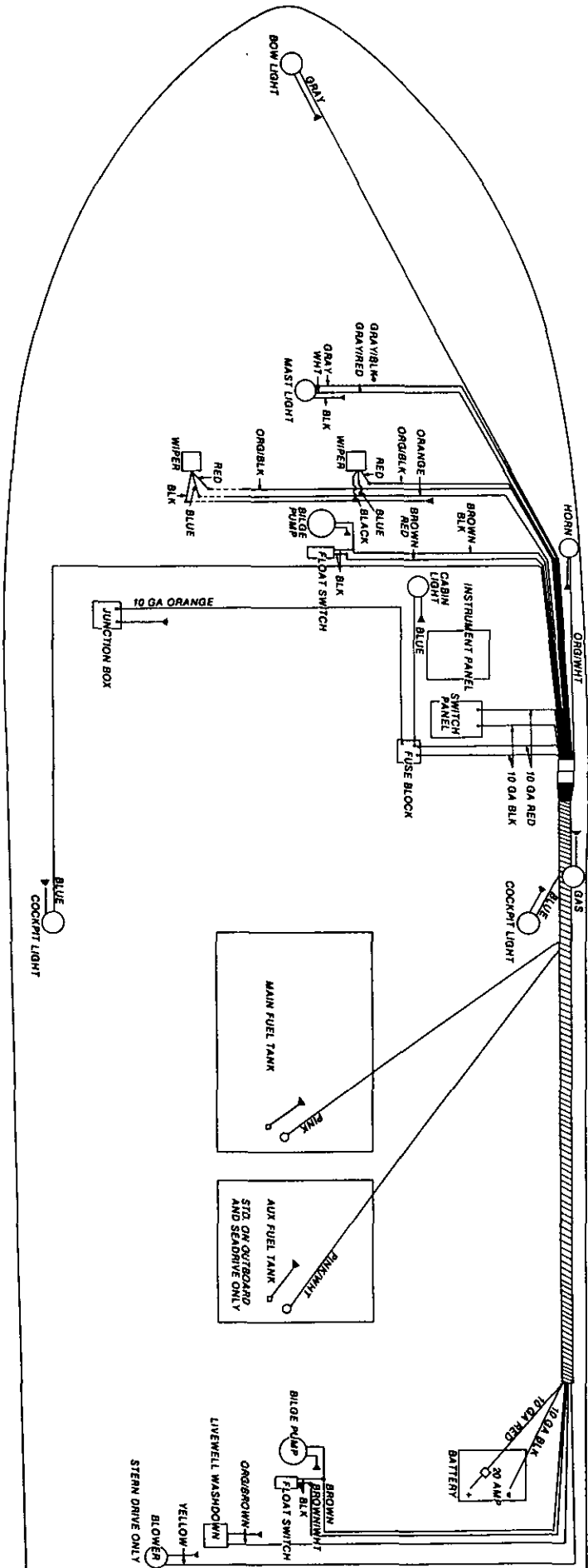

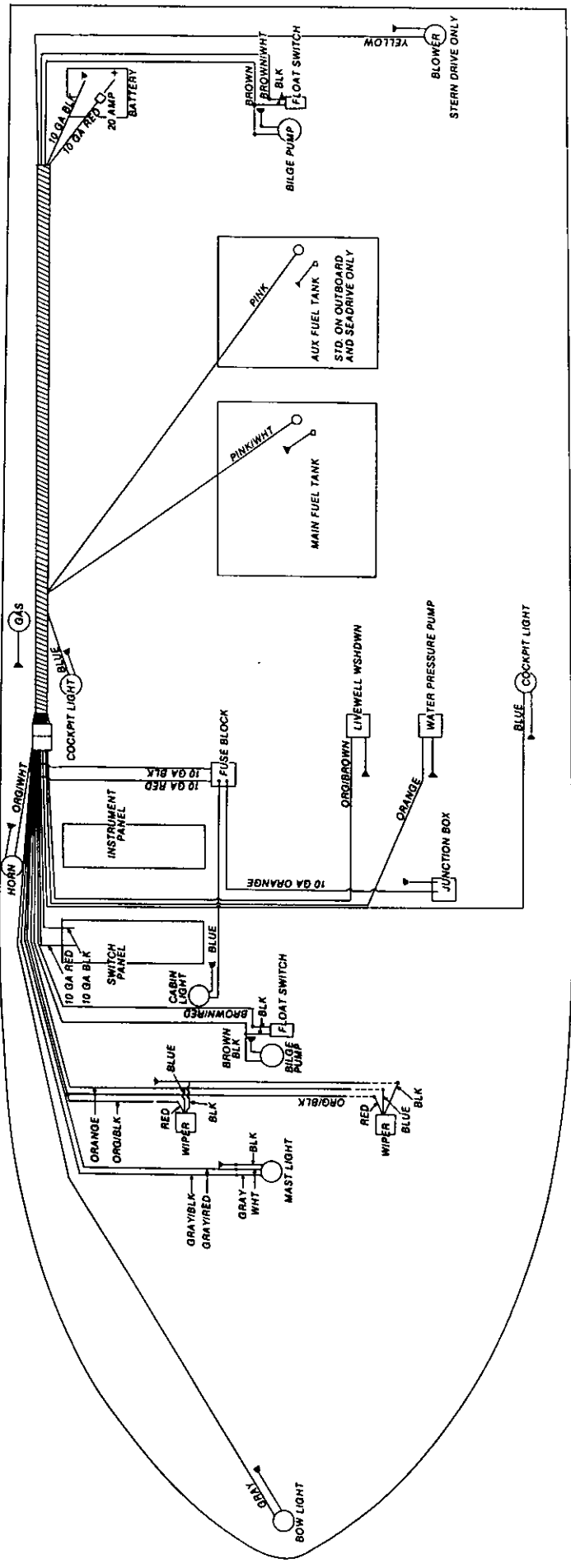

Accessory Wiring Diagram: 25' Trophy Series

# Hardtop Wiring Diagram

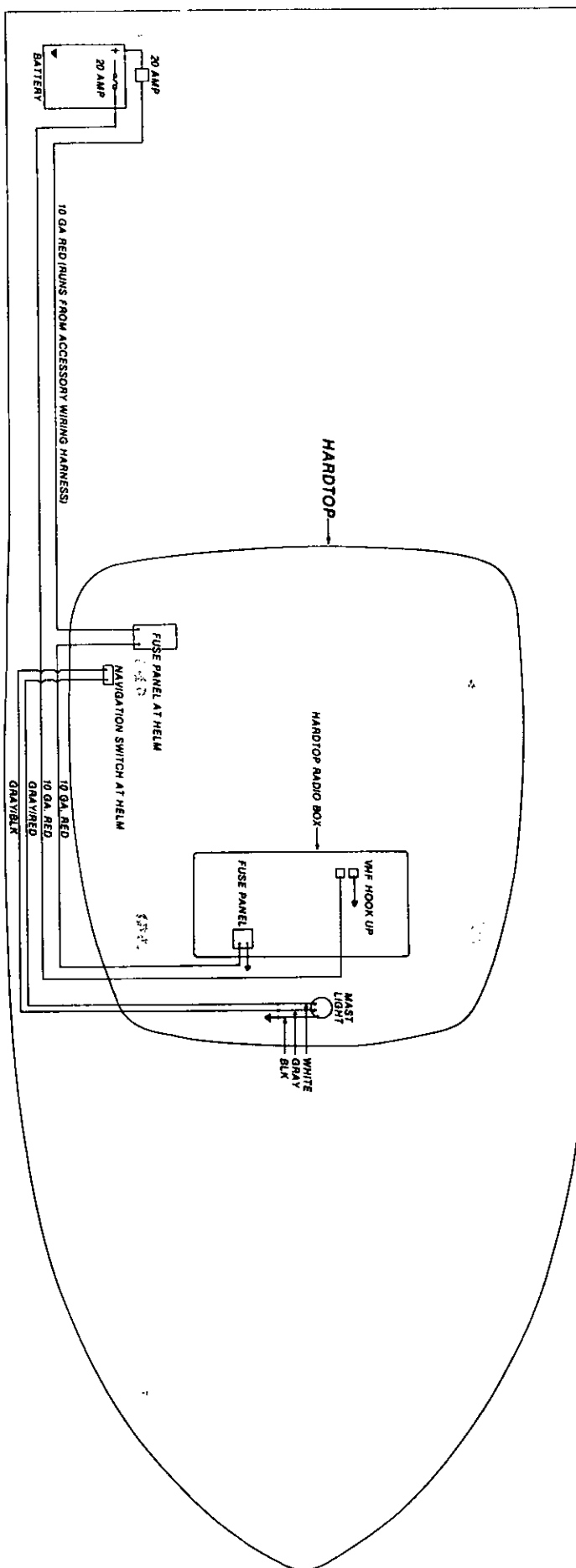

# Dockside Power Wiring Diagram: 25' Sailfish Series and 25' Trophy Series

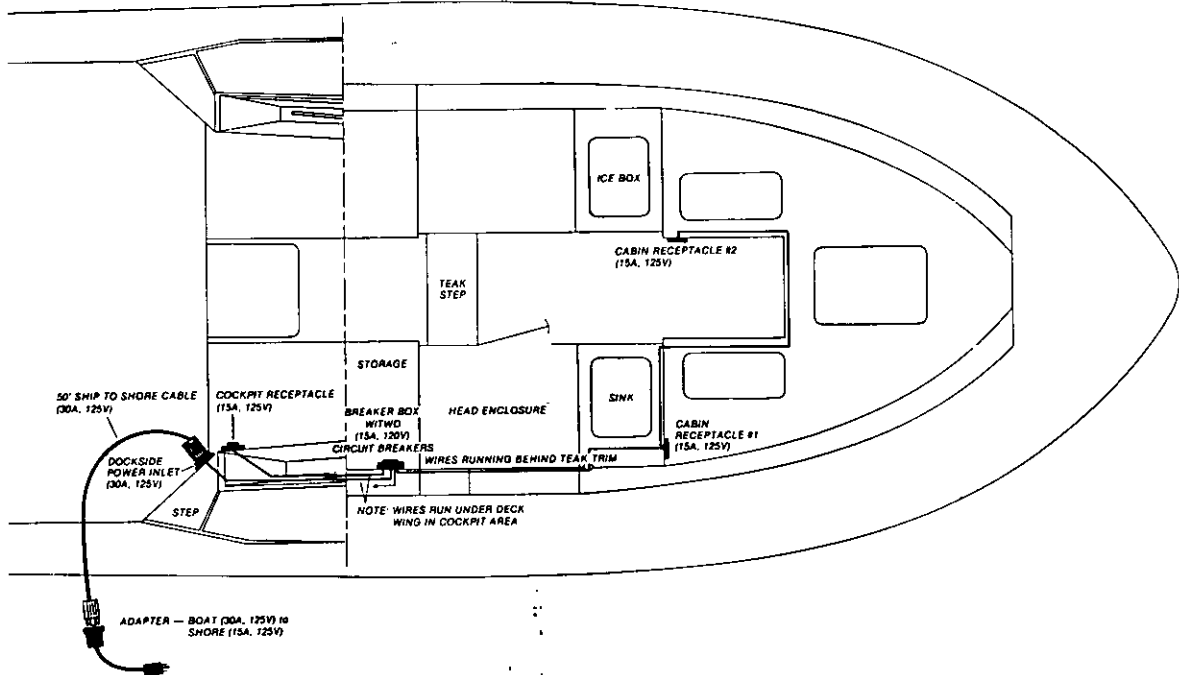
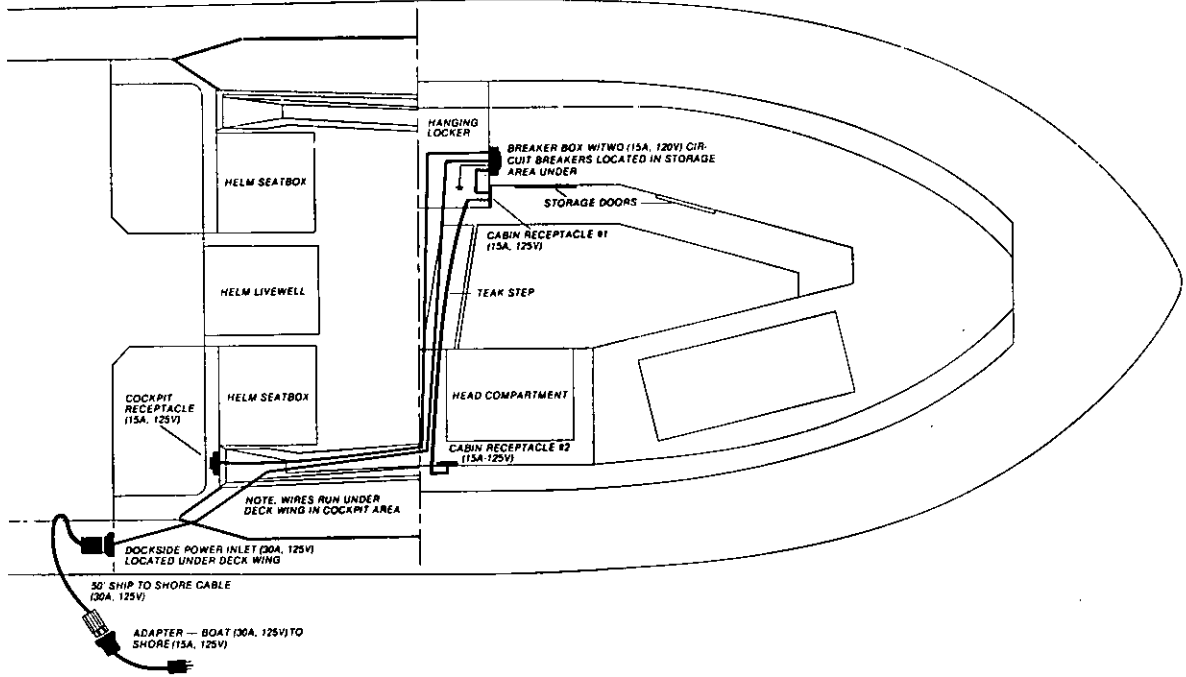

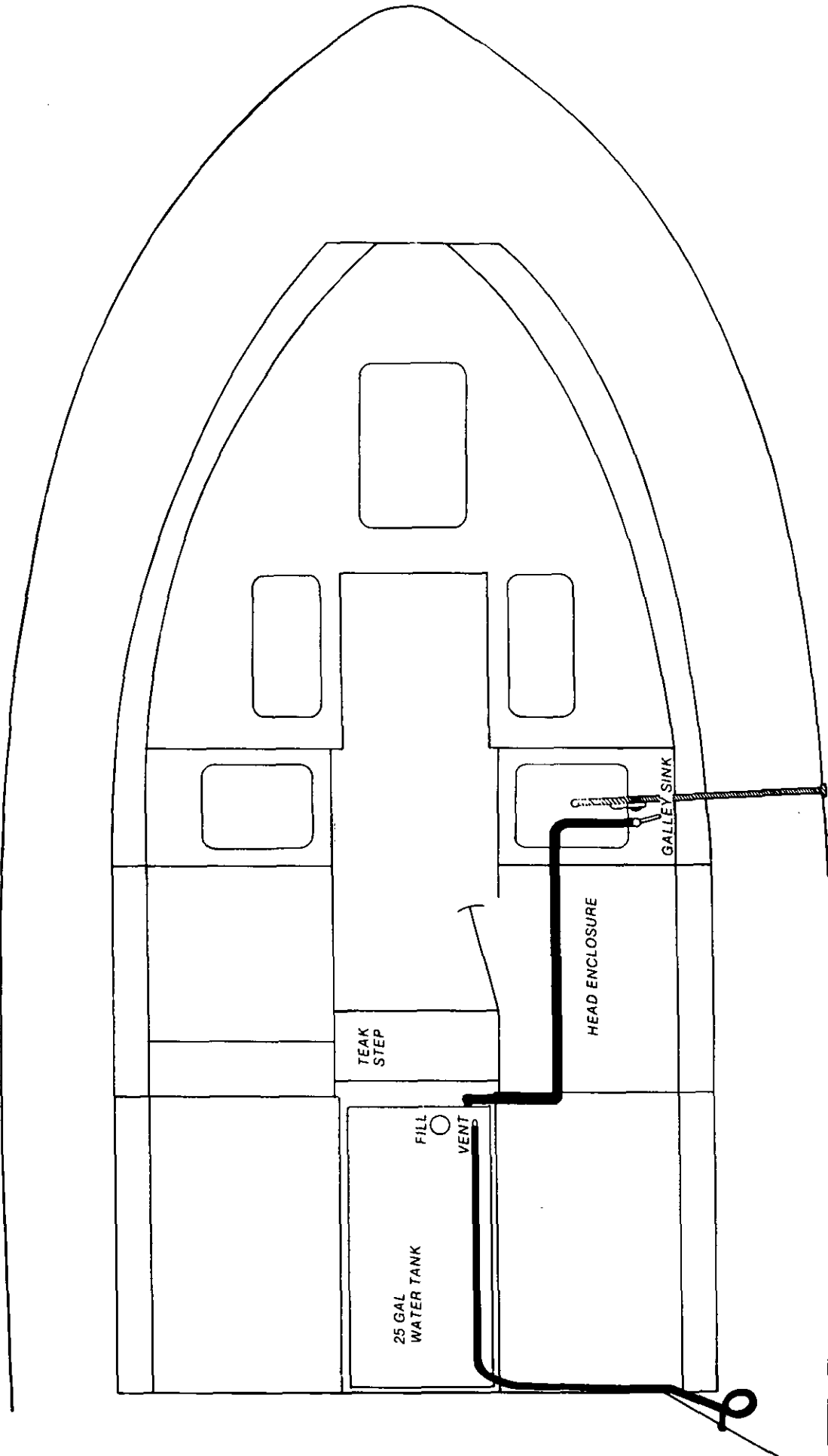

*Fresh Water System (Unpressurized): 25' Sailfish Series*

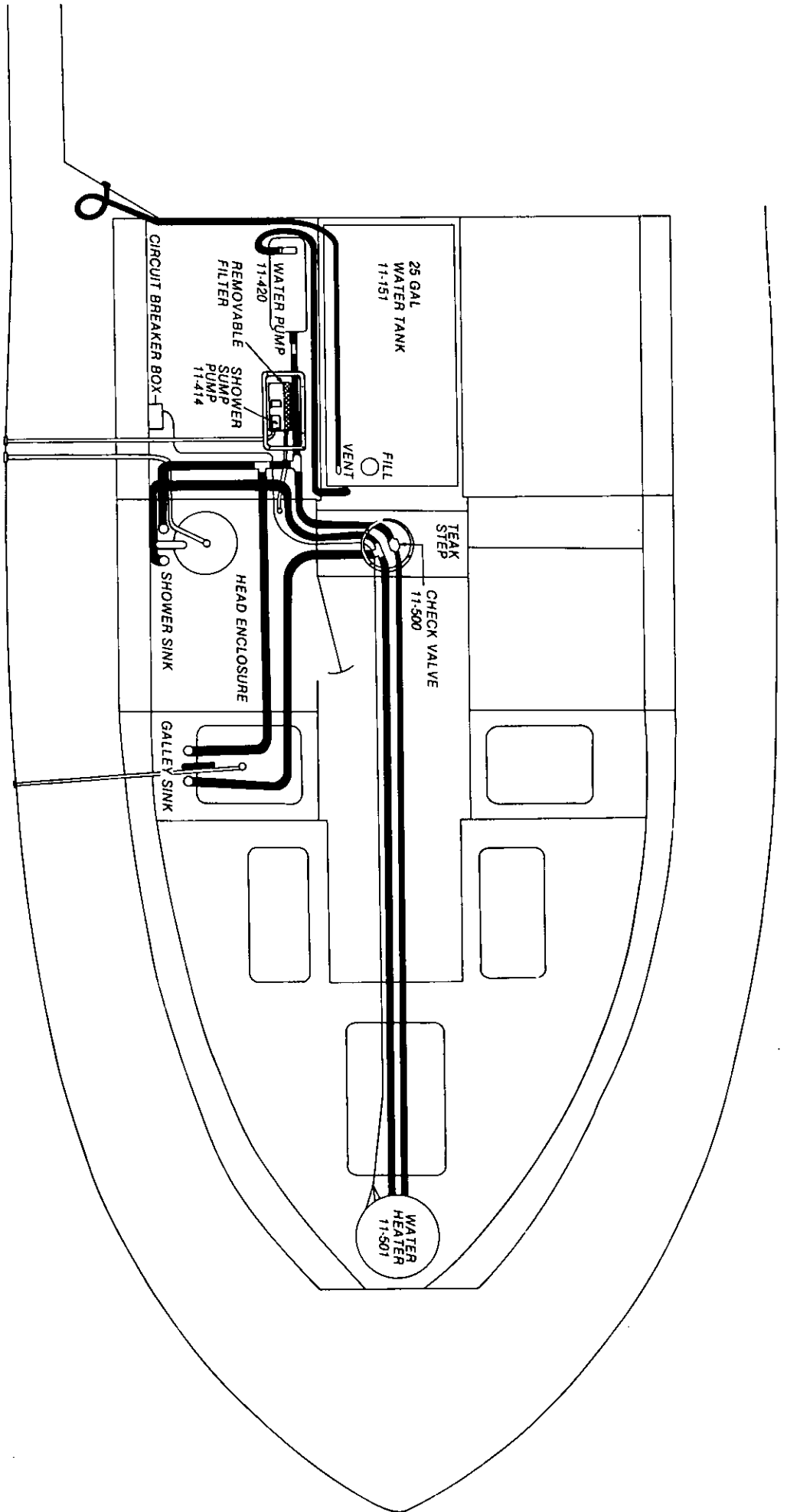

*Shower/Hot Water (Pressurized) System: 25' Sailfish Series*

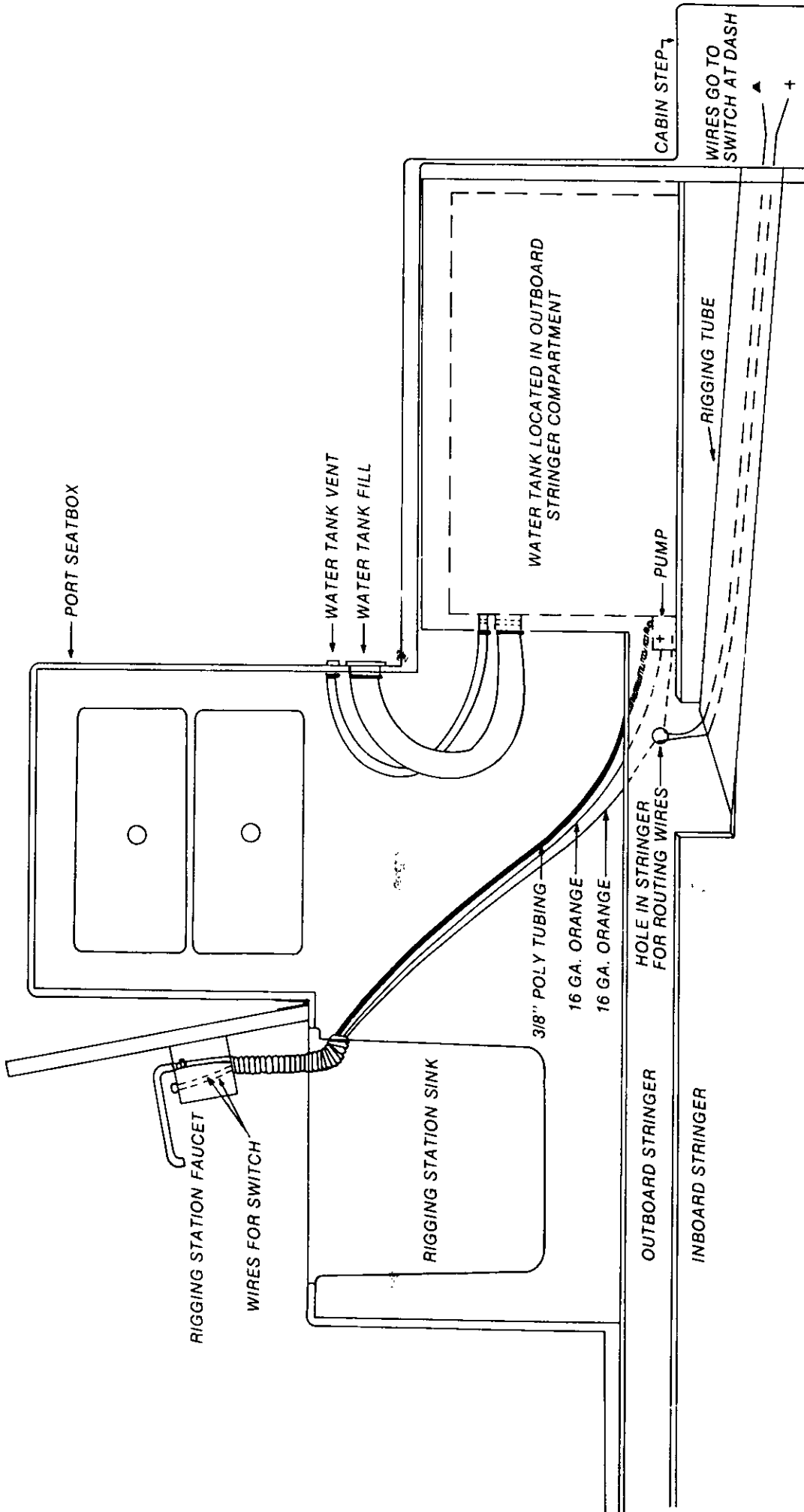

Fresh Water System (Pressurized): 25' Trophy Series



# Washdown/Livewell System

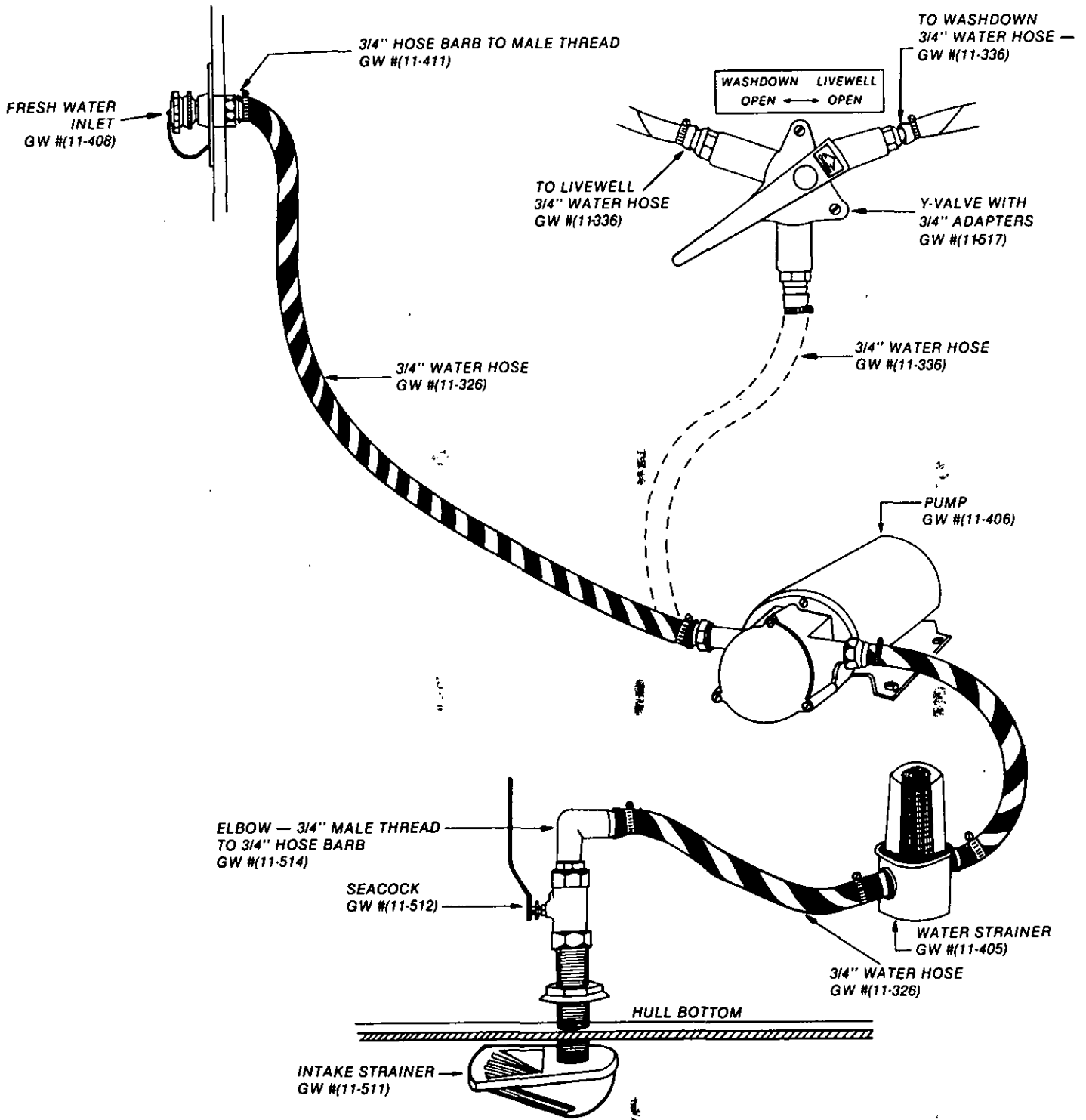

### Hull/Deck/Liner Layout

**Grady-White Construction**  
Most Grady-Whites are built in three separate fiberglass pieces, the hull, the deck and the fiberglass liner as shown below. These three pieces are bonded together after installation of standard through-bolted hardware, electrical systems, gas tanks and foam floatation.

**The deck**  
All standard hardware is mounted and secured with through bolts and locking nuts before being installed in the boat. The deck is then placed on the hull/liner and secured all around.

**The fiberglass liner**  
The fiberglass liner of your Grady-White is removed from its mold then all fishboxes and ice boxes are insulated with foam. The liner is then placed in the hull, the deck placed over both, and all three are bonded then secured with stainless steel screws all around.

**The hull**  
The wooden stringer system in your Grady-White is encapsulated in resin and fiberglass then fiberglassed into place while the hull is still in its mold. This gives your hull permanent strength and shape. Foam floatation is sprayed into strategic cavities between the stringers to add floatation, strength and sound absorption.

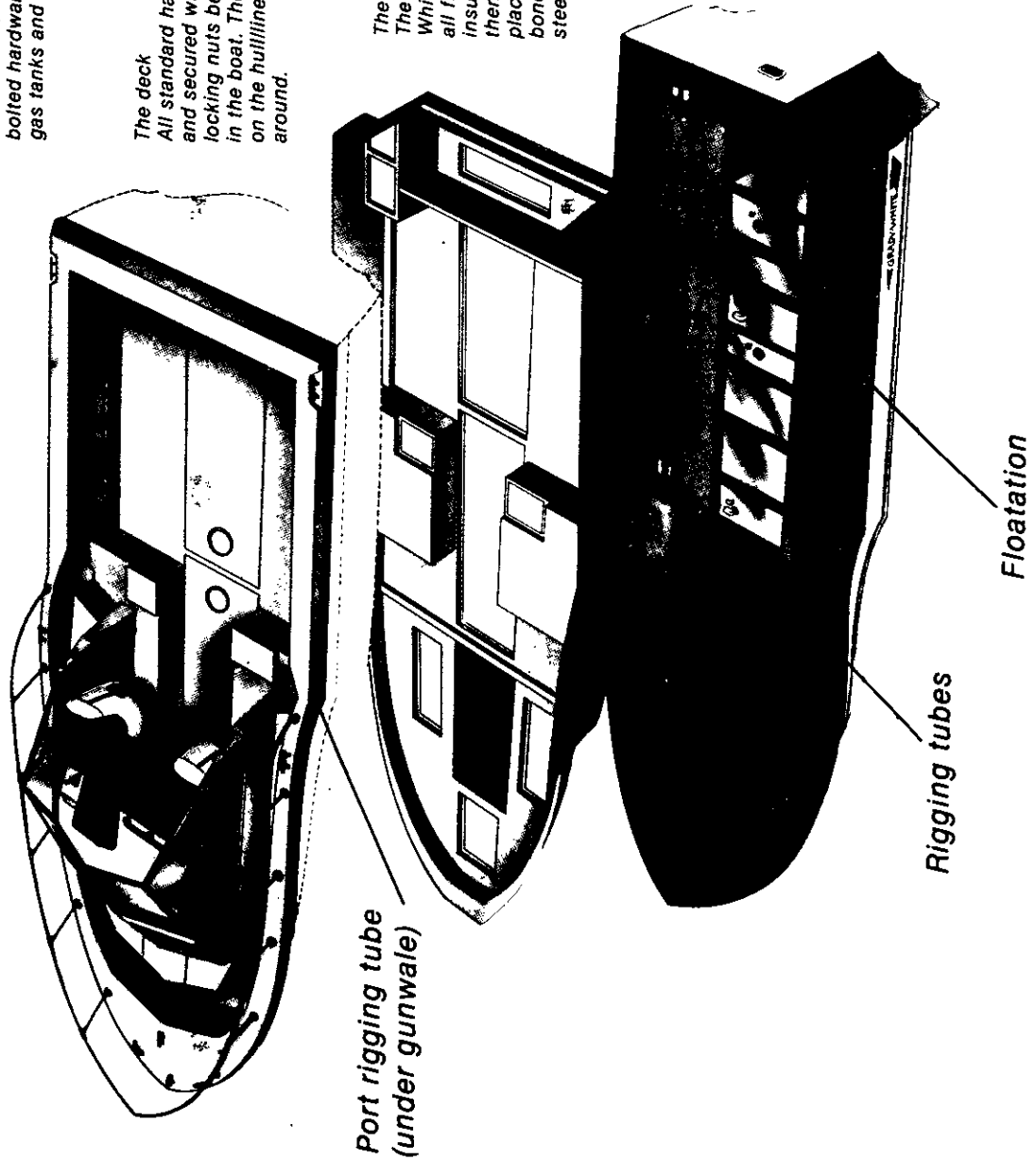

Port rigging tube  
(under gunwale)

Rigging tubes

Floatation

## commonly used nautical terms:

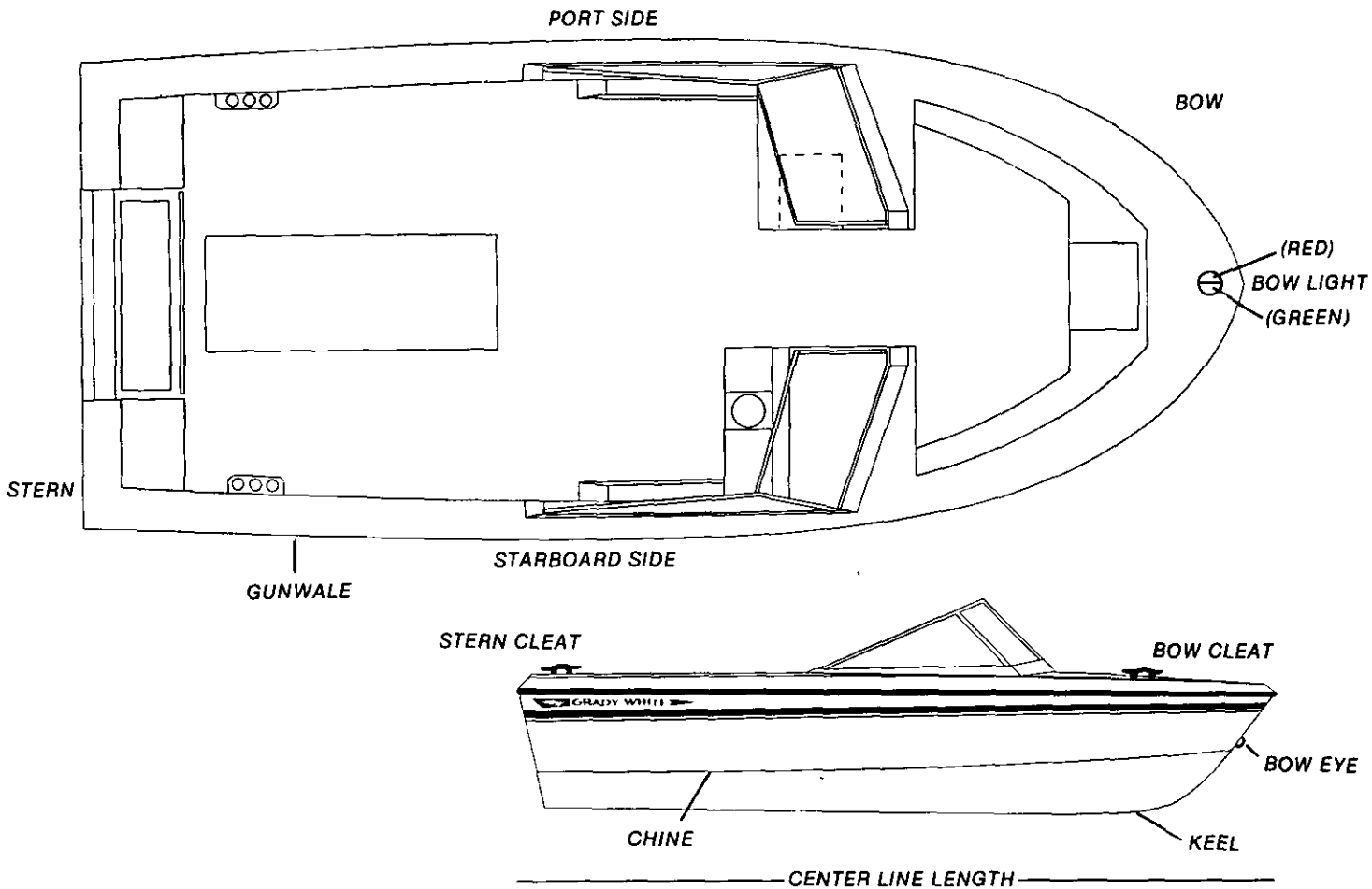

**abeam** — object 90 degrees to center line on either side of boat

**abaft** — a point on a boat that is aft of another

**aft** — toward the rear or stern of the boat

**beam** — the greatest width of a boat

**bilge** — the lower interior area of the hull

**bow** — the fore part of a boat

**bulkhead** — vertical partition in a boat

**chine** — meeting juncture of topside and bottom of boat

**chock** — deck fitting, used as guides for mooring or anchor lines

**cleat** — deck fitting with arms or horns on which lines may be made fast

**deck** — upper structure which covers the hull

**draft** — depth of water required to float boat

**fathom** — six feet

**freeboard** — height of topside from water line to the deck

**gunwale (or gunnel)** — meeting junction of hull and deck

**hatch** — an opening in the deck to provide access below

**head** — a toilet or toilet area in a boat

**headroom** — vertical distance between the deck and cabin or canopy top

**hull** — the basic part of a boat; a watertight vessel that provides buoyancy to float the weight of the craft and its load

**keel** — the major longitudinal member of a hull — the lowest external portion of a boat

**knot** — unit of speed in nautical miles per hour

**lee** — the side that is sheltered from the wind

**port** — opening in a hull to admit light and air or lateral directions — term designating left side of the boat

**port light** — a hinge or sliding port in a boat hull

**scupper** — holes permitting water to drain overboard from deck or cockpit

**sheer** — curve or sweep of the deck as viewed from the side

**starboard** — lateral direction term designating right side of the boat

**stern** — the aft end of a boat

**stringer** — longitudinal members fastened inside the hull for additional structural strength

**wake** — disturbed water that a boat leaves behind as a result of the motion

**windward** — toward the direction from which the wind is blowing

## LIMITED WARRANTY

**REGISTRATION OF PURCHASE:** The "Federal Boat Safety Act of 1971" requires all boat manufacturers to maintain a record of all first retail purchasers and their current address for the purpose of notification in case of defective parts or equipment, or in case of non-compliance with standards or regulations set forth by this act. Under the act, failure to complete and return your factory warranty card for our records will waive your right to notification of defect and/or repair at manufacturers expense.

### THREE YEAR HULL WARRANTY

Grady-White warrants to the original retail purchaser of each new Grady-White Boat that under normal use the hull will be free from structural defects for a period of three years from the date of delivery to the original retail purchaser. Any structural defects covered by the warranty will be repaired free of charge at either the Grady-White factory in Greenville, North Carolina, or at an authorized Grady-White dealer location as elected by Grady-White. Transportation to and from the point of repair will be the responsibility of the owner with all repairs subject to prior written authorization by Grady-White Boats, Incorporated. **NO BOAT IS TO BE SENT TO THE GRADY-WHITE FACTORY WITHOUT SUCH WRITTEN AUTHORITY.**

### ONE YEAR MATERIAL AND WORKMANSHIP WARRANTY

Grady-White further warrants to the original retail purchaser of each Grady-White boat that under normal use it will be free from defects in workmanship and material for a period of 12 months from the date of delivery to the original retail purchaser. Necessary repairs under this warranty will be made free of charge at Grady-White's factory in Greenville, North Carolina or at an authorized Grady-White dealer as elected by Grady-White. **NO BOAT OR PART THEREOF IS TO BE SENT TO THE GRADY-WHITE FACTORY WITHOUT SUCH WRITTEN AUTHORITY.**

### EXCLUSIONS

This warranty specifically does not include the following:

1. Damage caused by abuse, negligence, vandalism, lack of maintenance, improper storage or accident.
2. Any statements, representations, or warranties given by dealers or other third persons other than those provided within this warranty.
3. Any unit which is part of a rental fleet, used for racing or commercial purposes.
4. The following consequential damages: a) loss of time; b) inconvenience; c) towing charges; d) expenses for travel, lodging, telephone, and gasoline; e) loss or damage to personal property or loss of revenue; f) loss of use of the boat.
5. This warranty specifically does not apply to engines, outdrives, propellers, controls, mechanical steering, bilge pumps, and any other part expressly warranted by the manufacturer thereof. In addition, also excluded are gel coat cracking, gel coat crazing, gel coat blistering or fading, chrome, windshields, glass breakage, all vinyl upholstery and canvas, instruments and gauges, and leakage around windshields, windows, hatches, and other apertures.
6. Any boat which has been overpowered according to the maximum Grady-White recommended engine horsepower specifications on the capacity plate affixed to the boat.

### WARRANTY CLAIM PROCEDURES

Upon the discovery of a defect, the owner is to promptly contact the Grady-White dealer, from whom the owner purchased the boat who will effect the corrective action under this warranty upon prior written authorization from Grady-White Boats, Incorporated.

**THESE WARRANTIES ARE EXPRESSLY MADE IN LIEU OF ALL OTHER WARRANTIES, DURATION OF ANY IMPLIED WARRANTY OF MERCHANTABILITY OR FITNESS FOR A PARTICULAR PURPOSE OR OTHERWISE SHALL BE LIMITED TO AND COINCIDENT WITH THE DURATION OF THESE EXPRESSED WARRANTIES.**

**THIS WARRANTY SHALL NOT BE VALID UNLESS THE FACTORY WARRANTY POSTCARD IS PROPERLY EXECUTED AND MAILED WITHIN 10 DAYS OF THE PURCHASE OF YOUR GRADY-WHITE BOAT.**

GRADY-WHITE BOATS, INC.  
P.O. Box 1527  
Greenville, N.C. 27834